

Purestone

CERAMICHE PIEMME
FLOOR AND MORE

Purestone



Una vera e propria materia d'arredo,
ricavata elaborando l'estetica
di diverse pietre esistenti in natura.
"Purestone" Piemme è un moderno
grès porcellanato dai toni delicati
e dalle venature discrete, mai eccessive.

A real furnishing material, obtained by processing
the aesthetics of various kinds of natural stones,
Piemme "Purestone" is a modern porcelain stoneware with
delicate colour shades and discreet and never excessive veins.

Ein echtes Einrichtungsmaterial, gewonnen
aus einem Mix der Optik verschiedener Natursteine.
Piemme "Purestone" ist ein modernes Feinsteinzeug in zarten
Tönen und mit dezenten, unaufdringlichen Aderungen.

Cette véritable révolution en matière d'architecture intérieure est le fruit
d'une étude précise sur les différentes pierres existant dans la nature.
"Purestone" by Piemme est un grès cérame moderne,
aux teintes délicates, aux veines discrètes parfaitement dosées.

Strutture - Structures

* 80x80cm 31^{1/2}" x 31^{1/2}"
60x60cm 24" x 24"
30x60cm 12" x 24"
30,1x60,4cm 12" x 24"

naturale

* 80x80cm 31^{1/2}" x 31^{1/2}"
60x60cm 24" x 24"
30x60cm 12" x 24"

levigato

30x60cm 12" x 24"

velvet

linea
30x60cm 12" x 24"

muretto
30x60cm 12" x 24"



Purestone

Purestone entra con
il suo **stile contemporaneo**
in ogni ambiente,
sia residenziale che pubblico.

With its **contemporary design**, Purestone
is suitable for **any environment**,
both residential and public.

Purestone fügt sich mit seinem zeitgerechten
Stil harmonisch in jedes Ambiente ein, sei es
im Wohnungsbau oder in öffentlichen Bereichen.

Le style Purestone trouve sa place
dans **tout environnement contemporain**,
qu'il soit privé ou collectif.

grigio nat/ret 80x80 cm - 31¹/₂"x31¹/₂"
HOLLAND - VAN DER VALK HOTEL HOORN

grigio nat/ret 80x80 cm - 31¹/₂"x31¹/₂" / battiscopa grigio nat/ret 8x80 cm - 3¹/₈"x31¹/₂"
HOLLAND - VAN DER VALK HOTEL HOORN



Hotel



grigio nat/ret 80x80 cm - 31¹/₂"x31¹/₂"



grigio nat/ret 80x80 cm - 31¹/₂"x31¹/₂"
battiscopa grigio nat/ret 8x80 cm - 3¹/₈"x31¹/₂"

Public Spaces



beige nat/ret 80x80 cm - 31¹/₂"x31¹/₂"



muretto beige nat/ret 30x60 cm - 12"x24"



bianco nat/ret 80x80 cm - 31¹/₂"x31¹/₂" / linea bianco nat/ret 30x60 cm - 12"x24"
muretto bianco nat/ret 30x60 cm - 12"x24"

Purestone

Un'anima tecnica ed una superficie di design rendono Purestone **duttile per qualsiasi impiego**, per la pavimentazione o il rivestimento murale; la tridimensionalità di "linea" e "muretto", dá **un tocco di stile** al mood dell'ambiente.

A technological heart and a design surface make Purestone **adaptable for any use**, for floors or wall coverings; the three-dimensionality of "linea" and "muretto" gives a **touch of style** to the environment mood.

Mit seiner technischen Seele und der Design-Oberfläche passt sich Purestone **allen Orten** als Bodenbelag oder Wandverkleidung an; die dreidimensionale Struktur von "Linea" und "Muretto" verleiht jedem Raum **stilvolles Flair**.

Avec son esprit technique et sa surface design, Purestone se prête à toute utilisation, en carrelage sol ou en revêtement mural. La tridimensionnalité de "linea" et de "muretto" apporte **une note de style** à l'esthétique de l'environnement.

beige lev/ret 60x60 cm - 24"x24" / linea beige nat/ret 30x60 cm - 12"x24"

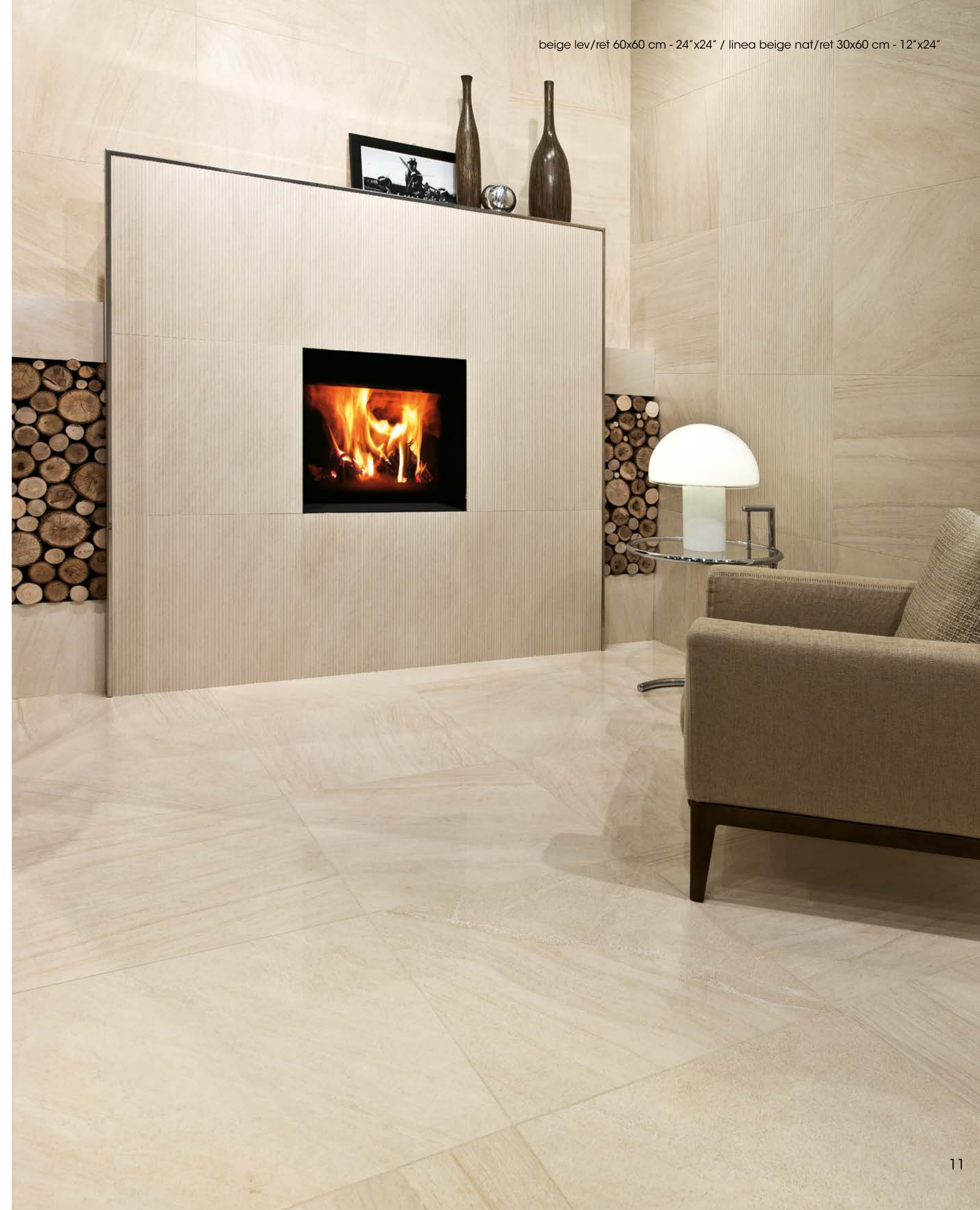



Purestone può **arredare con sobria eleganza** ogni moderno ambiente residenziale, **coordinandone lo stile fra interno ed esterno** grazie alla superficie antiscivolo "velvet".

Purestone is able to furnish every modern residential environment with sober elegance, coordinating its interior and outdoor style thanks to the "velvet" non-slip surface.

"Purestone" gestaltet mit schlichter Eleganz jeden modernen Wohnraum und erzeugt dank der rutschfesten Oberfläche "Velvet" eine stilistische Einheit von Innen und Außen.

Purestone pare de sa sobre élégance tout espace de vie moderne alors que la surface antiglissance de "velvet" permet la continuité du style entre l'intérieur et l'extérieur.

antracite lev/ret 60x60 cm - 24"x24"



Living

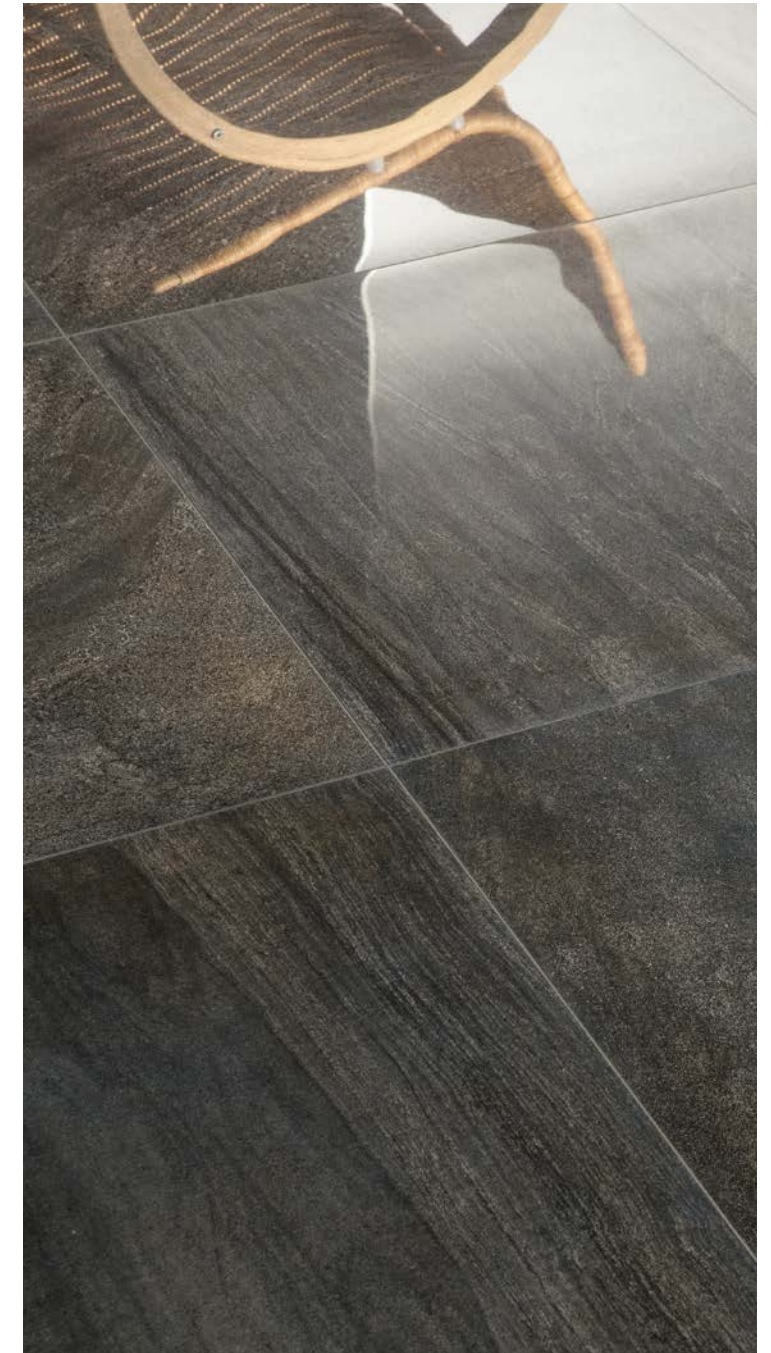

antracite lev/ret 60x60 cm - 24"x24"

Colori e Formati

Sizes and colors - Formate und Farben - Formats et couleurs

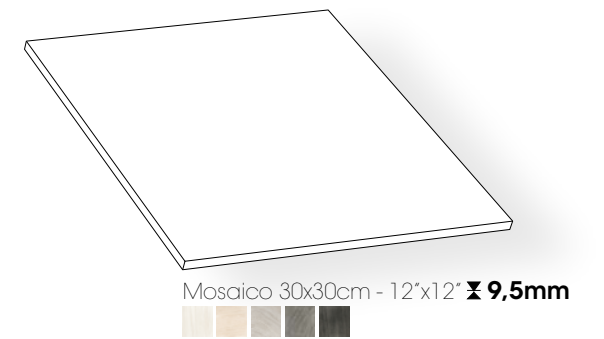
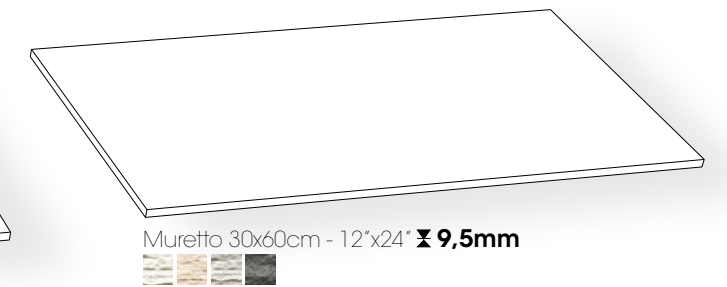
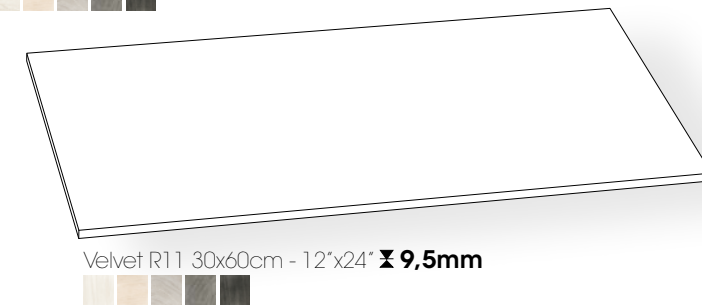
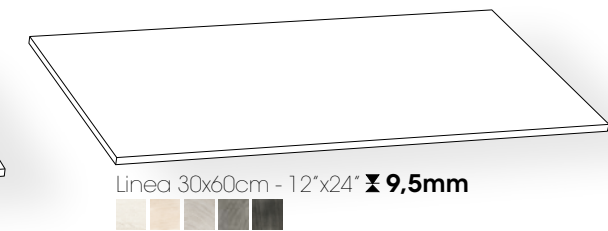
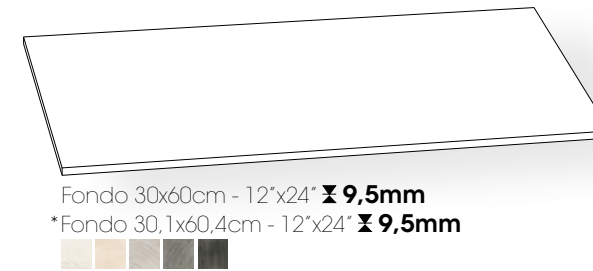
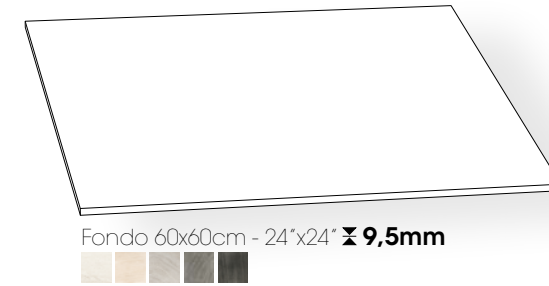
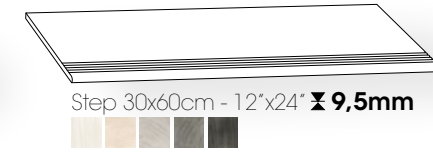
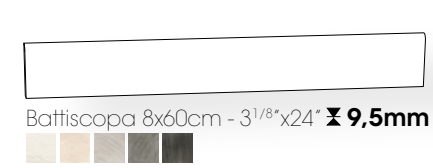
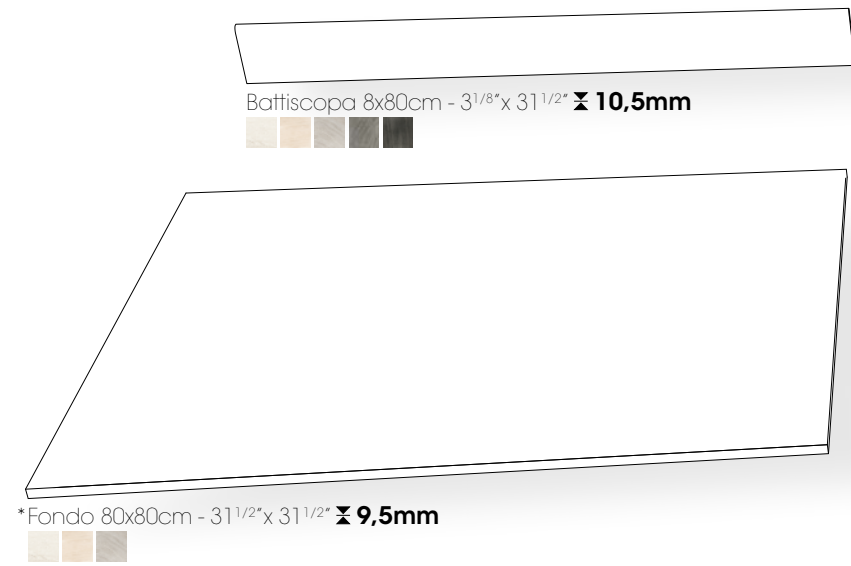

Bianco

Beige

Grigio

Piombo

Antracite



*Attenzione: verificare in fase di ordine il codice e l'imballo (80x80-30,1x60,4)
 *Note: In the ordering phase please check code and packaging (80x80-30,1x60,4)
 *Bitteachten: Beim Bestellen bitte die Kodenummer und die Verpackung kontrollieren (80x80-30,1x60,4)
 *Attention : Merci de vérifier emballage et la référence au moment de la commande (80x80-30,1x60,4)

Bianco

GRES FINE PORCELLANATO AD IMPASTO COLORATO
COLOURED-BODY FINE PORCELAIN STONWARE
FEINSTEINZEUG AUS FARBIGER MASSE
GRÈS CÉRAME FIN À PÂTE COLORÉE

TECNOLOGIA DIGITALE
DIGITAL TECHNOLOGY
DIGITAL TECHNOLOGIE
TECNOLOGIE NUMÉRIQUE

60x60 cm
24"x24"
30x60 cm
12"x24"
9,5 mm

80x80 cm
31^{1/2}"x31^{1/2}"
9,5 mm



03635 PURESTONE BIANCO NAT/RET
03636 PURESTONE BIANCO LEV/RET
80x80 - 31^{1/2}"x 31^{1/2}"

U4 P3 E3 C2
V3



10840 PURESTONE BIANCO NAT/RET
10870 PURESTONE BIANCO LEV/RET
60x60 - 24"x24"

V3



03774 PURESTONE BIANCO NAT
30,1x60,4 - 12"x24"

U4 P3 E3 C2

10990 PURESTONE BIANCO NAT/RET
11080 PURESTONE BIANCO LEV/RET
30x60 - 12"x24"

V3



00530 PURESTONE BIANCO VELVET RET
30x60 - 12"x24"



00535 PURESTONE LINEA BIANCO NAT/RET
30x60 - 12"x24"



11160 PURESTONE MURETTO BIANCO NAT/RET
30x30 - 12"x12"



39590 MOSAICO BIANCO NAT/RET
30x30 - 12"x12" (pz box 5)

bianco nat/ret 60x60 cm - 24"x24"

Beige

GRES FINE PORCELLANATO AD IMPASTO COLORATO
COLOURED-BODY FINE PORCELAIN STONEWARE
FEINSTEINZEUG AUS FARBIGER MASSE
GRÈS CÉRAME FIN À PÂTE COLORÉE

TECNOLOGIA DIGITALE
DIGITAL TECHNOLOGY
DIGITAL TECHNOLOGIE
TECNOLOGIE NUMÉRIQUE

60x60 cm
24"x24"
30x60 cm
12"x24"
9,5 mm

80x80 cm
31¹/₂"x31¹/₂"
9,5 mm



03857 PURESTONE BEIGE NAT/RET
03859 PURESTONE BEIGE LEV/RET
80x80 - 31¹/₂"x 31¹/₂"

U4 P3 E3 C2
V3



10850 PURESTONE BEIGE NAT/RET
10880 PURESTONE BEIGE LEV/RET
60x60 - 24"x24"

V3



03775 PURESTONE BEIGE NAT
30,1x60,4 - 12"x24"

U4 P3 E3 C2



00531 PURESTONE BEIGE VELVET RET
30x60 - 12"x24"



00536 PURESTONE LINEA BEIGE NAT/RET
30x60 - 12"x24"

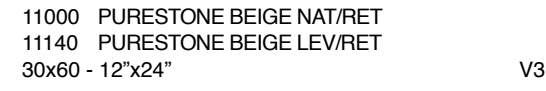

11000 PURESTONE BEIGE NAT/RET
11140 PURESTONE BEIGE LEV/RET
30x60 - 12"x24"

V3



11300 PURESTONE MURETTO BEIGE NAT/RET
30x60 - 12"x24"

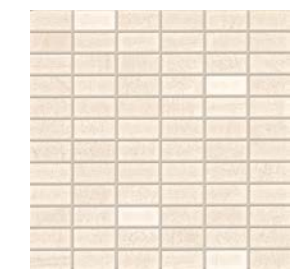

39600 MOSAICO BEIGE NAT/RET
30x30 - 12"x12" (pz box 5)

beige nat/ret 60x60 cm - 24"x24"

Grigio

GRES FINE PORCELLANATO AD IMPASTO COLORATO
COLOURED-BODY FINE PORCELAIN STONWARE
FEINSTEINZEUG AUS FARBIGER MASSE
GRÈS CÉRAME FIN À PÂTE COLORÉE

TECNOLOGIA DIGITALE
DIGITAL TECHNOLOGY
DIGITAL TECHNOLOGIE
TECNOLOGIE NUMÉRIQUE

60x60 cm
24"x24"
30x60 cm
12"x24"
9,5 mm

80x80 cm
31^{1/2}"x31^{1/2}"
9,5 mm



03858 PURESTONE GRIGIO NAT/RET
03861 PURESTONE GRIGIO LEV/RET
80x80 - 31^{1/2}"x 31^{1/2}"

U4 P3 E3 C2
V3



10860 PURESTONE GRIGIO NAT/RET
10890 PURESTONE GRIGIO LEV/RET
60x60 - 24"x24"

V3



03776 PURESTONE GRIGIO NAT
30,1x60,4 - 12"x24"

U4 P3 E3 C2



00532 PURESTONE GRIGIO VELVET RET
30x60 - 12"x24"



00537 PURESTONE LINEA GRIGIO NAT/RET
30x60 - 12"x24"

11070 PURESTONE GRIGIO NAT/RET
11150 PURESTONE GRIGIO LEV/RET
30x60 - 12"x24"

V3



11310 PURESTONE MURETTO GRIGIO NAT/RET
30x60 - 12"x24"



39610 MOSAICO GRIGIO NAT/RET
30x30 - 12"x12" (pz box 5)

grigio nat/ret 60x60 cm - 24"x24"

Piombo

GRES FINE PORCELLANATO AD IMPASTO COLORATO
COLOURED-BODY FINE PORCELAIN STONEWARE
FEINSTEINZEUG AUS FARBIGER MASSE
GRÈS CÉRAME FIN À PÂTE COLORÉE

TECNOLOGIA DIGITALE
DIGITAL TECHNOLOGY
DIGITAL TECHNOLOGIE
TECNOLOGIE NUMÉRIQUE

60x60 cm
24"x24"
30x60 cm
12"x24"
9,5 mm



00519 PURESTONE PIOMBO NAT/RET
00522 PURESTONE PIOMBO LEV/RET
60x60 - 24"x24"

V3



03777 PURESTONE PIOMBO NAT
30,1x60,4 - 12"x24"

00526 PURESTONE PIOMBO NAT/RET
00528 PURESTONE PIOMBO LEV/RET
30x60 - 12"x24"

V3



00533 PURESTONE PIOMBO VELVET RET
30x60 - 12"x24"



00538 PURESTONE LINEA PIOMBO NAT/RET
30x60 - 12"x24"



00725 PURE. MURETTO PIOMBO/ANT NAT/RET
30x60 - 12"x24"

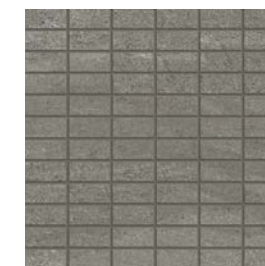

00540 MOSAICO PIOMBO NAT/RET
30x30 - 12"x12" (pz box 5)

Antracite

GRES FINE PORCELLANATO AD IMPASTO COLORATO
COLOURED-BODY FINE PORCELAIN STONEWARE
FEINSTEINZEUG AUS FARBIGER MASSE
GRÈS CÉRAME FIN À PÂTE COLORÉE

TECNOLOGIA DIGITALE
DIGITAL TECHNOLOGY
DIGITAL TECHNOLOGIE
TECNOLOGIE NUMÉRIQUE

60x60 cm
24"x24"
30x60 cm
12"x24"
9,5 mm



00521 PURESTONE ANTRACITE NAT/RET
00523 PURESTONE ANTRACITE LEV/RET
60x60 - 24"x24"

V3



03778 PURESTONE ANTRACITE NAT
30,1x60,4 - 12"x24"



00534 PURESTONE ANTRACITE VELVET RET
30x60 - 12"x24"



00539 PURESTONE LINEA ANTRACITE NAT/RET
30x60 - 12"x24"

00527 PURESTONE ANTRACITE NAT/RET
00529 PURESTONE ANTRACITE LEV/RET
30x60 - 12"x24"

V3



00725 PURE. MURETTO PIOMBO/ANT NAT/RET
30x60 - 12"x24"

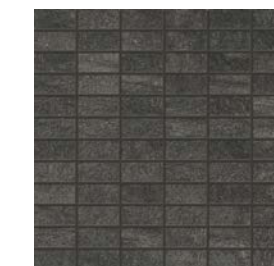

00541 MOSAICO ANTRACITE NAT/RET
30x30 - 12"x12" (pz box 5)

Pezzi Speciali

Special Pieces - Formteile - Pièces Spéciales

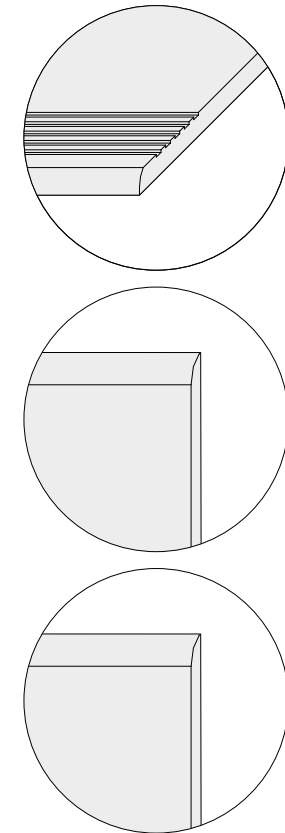
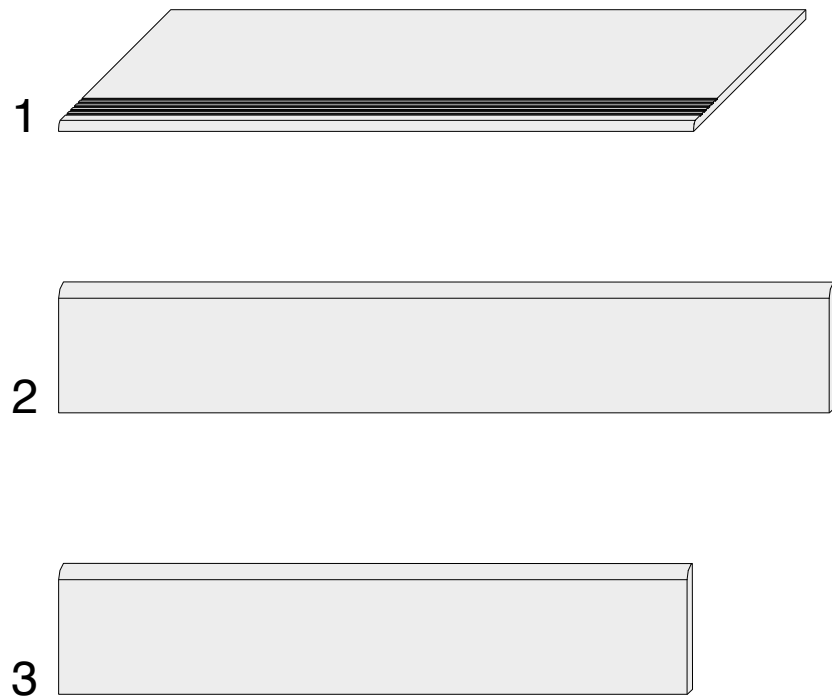

1 STEP 30x60cm pz. box:6

- 11390 STEP BIANCO NAT
- 11400 STEP BEIGE NAT
- 11410 STEP GRIGIO NAT
- 00550 STEP PIOMBO NAT
- 00551 STEP ANTRACITE NAT

2 BATTISCOPA 8x80cm* pz. box:7

- 33390 BATTISCOPA BIANCO NAT/RET
- 34100 BATTISCOPA BEIGE NAT/RET
- 34110 BATTISCOPA GRIGIO NAT/RET

3 BATTISCOPA 8x60cm pz. box:10

- 11320 BATTISCOPA BIANCO
- 71980 BATTISCOPA BIANCO RET
- 72010 BATTISCOPA BIANCO LEV
- 11330 BATTISCOPA BEIGE
- 71990 BATTISCOPA BEIGE RET
- 72020 BATTISCOPA BEIGE LEV
- 11380 BATTISCOPA GRIGIO
- 72000 BATTISCOPA GRIGIO RET
- 72030 BATTISCOPA GRIGIO LEV
- 00542 BATTISCOPA PIOMBO
- 00544 BATTISCOPA PIOMBO RET
- 00546 BATTISCOPA PIOMBO LEV
- 00543 BATTISCOPA ANTRACITE
- 00545 BATTISCOPA ANTRACITE RET
- 00547 BATTISCOPA ANTRACITE LEV

*disponibile su richiesta anche lev/ret
polished and rectified available on demand
nach Anfrage auch poliert/kalibriert erhältlich
sur demande disponible aussi en lev/rect

Imballi

Packing - Verpackung - Emballage

FORMATI SIZES	SPESSORI THICKNESS	SUPERFICIE SURFACE	BIANCO	BEIGE	GRIGIO	PIOMBO	ANTRACITE	IMBALLI PACKING	Pezzi/Scatola Pcs/Box Carreaux/Bolles	Mg/Scatola Spesi/Box M2/Karton Om/Bolles	Kg/Scatola Kgr/Box Kg/Bolles	Scatole/Palletta Boxes/Pallet Kartons/Palette Bolles/Pallet	Mg/Palletta Spesi/Pallet M2/Palette Om/Pallet	Kg/Palletta Kgr/Pallet Kg/Pallet
			●	●	●	●	●		●	●	●	●	●	●
80x80 / 31 ^{1/2} x31 ^{1/2}	9,5mm	NAT / RET	●	●	●	-	-		2	1,28	27,50	50	64	1375
		LEV / RET	●	●	●	-	-							
60x60 / 24"x24"	9,5mm	NAT / RET	●	●	●	●	●		3	1,08	21,5	40	43,2	860
		LEV / RET	●	●	●	●	●			22,5			900	
30,1x60,4 / 12"x24"	9,5mm	NAT	●	●	●	●	●		6	1,091	22	48	52,368	1056
30x60 / 12"x24"	9,5mm	NAT / RET	●	●	●	●	●		6	1,08	21	48	51,84	1032
		LEV / RET	●	●	●	●	●				22,5			
VELVET 30x60 / 12"x24"	9,5mm	RET	●	●	●	●	●		6	1,08	21,5	48	51,84	1032
LINEA 30x60 / 12"x24"	9,5mm	NAT / RET	●	●	●	●	●		6	1,08	21,5	40	43,2	860
MURETTO 30x60 / 12"x24"	9,5mm	NAT / RET	●	●	●	●	●		6	1,08	22,5	40	43,2	900
MOSAICO 30x30 / 12"x12"	9,5mm	NAT / RET	●	●	●	●	●		5	0,45	8,5	60	-	-
PEZZI SPECIALI - SPECIAL PIECES														
STEP 30x60 / 12"x24"	9,5mm	RET	●	●	●	●	●	6	1,08	22	36	-	-	
BATTISCOPA 8x60 / 31 ^{1/2} x24"	9,5mm	NAT	●	●	●	●	●	10	0,48 m.l. 6,00	11	72	-	-	
		NAT / RET	●	●	●	●	●							
		LEV / RET	●	●	●	●	●							
BATTISCOPA 8x80 / 31 ^{1/2} x31 ^{1/2} "	10,5mm	NAT / RET	●	●	●	●	●	7	0,448 m.l. 5,60	11	65	-	-	

*Attenzione: verificare in fase di ordine il codice e l'imballo (80x80-30,1x60,4)
*Note: In the ordering phase please check code and packaging (80x80-30,1x60,4)
*Bitteachten: Beim Bestellen bitte die Kodenummer und die Verpackung kontrollieren (80x80-30,1x60,4)
*Attention: Merci de vérifier emballage et la référence au moment de la commande (80x80-30,1x60,4)

Gli spessori riportati in questo catalogo sono nominali e possono variare a seconda dei formati e delle finiture.
The thickness mentioned on this catalogue are nominal and can be different according to the sizes and the finishes.
Die angegebene Fliesenstärke sind Nominal und können verschieden sein je nach Format oder Oberfläche.
Les épaisseurs reportées sur ce catalogue sont nominales et peuvent varier suivant les formats et les finitions.

Per una migliore resa estetica Piemme consiglia stuccature colorate in tinta con le piastrelle.
For a better aesthetic finish, Piemme recommends using jointing colours that match the tiles.
Für ein optisch perfektes Ergebnis empfiehlt Piemme, die Fugen farblich auf die Fliesen abzustimmen.
Pour parfaire l'effet esthétique obtenu, Piemme conseille de confectionner des joints de la même couleur que les carreaux.

Per i prodotti rettificati consigliamo una fuga di 2 mm per un migliore risultato di posa.
For better installation results of rectified products, we suggest 2 mm joint.
Damit sich eine bessere Verlegung von geschliffenen Produkten ergibt, empfehlen wir eine Fugenbreite von 2 mm.
Pour obtenir le meilleur résultat de pose de produits rectifiés, il est conseillé de réaliser un joint de 2 mm.













■	▲	◀▶
Fascia prezzo al metro quadro Square meter price range Quadratmeter preisgruppe Niveau de prix au mètre carré	Fascia prezzo al pezzo Price range per piece Stück preisgruppe Niveau de prix à la pièce	Spessore mm Thickness mm Stärke mm Épaisseur mm

Le tonalità dei colori sono indicative
The colour shades are indicative
Die farbtonne sind annähernd
Les tonalités des couleurs sont indicatives

Caratteristiche Tecniche

Technical Characteristics - Technische Daten - Caracteristiques Techniques

Classificazione secondo norme EN 14411 BI_A - Iso 13006 - Classification in accordance with EN 14411 BI_A - Iso 13006
 Klassifizierung gemäß Normen EN 14411 BI_A - Iso 13006 - Classification selon les normes EN 14411 BI_A - Iso 13006

	Caratteristica Tecnica Technical Characteristic Technische Date Caractéristique Technique	Norma Norm Norm Norme	Valore prescritto Value required Normvorgabe Valeur prescrite	Valore medio Mean value Mittelwert Valeur moyenne	USA tests 	Valore medio Mean value Mittelwert Valeur moyenne
	Lunghezza e larghezza Length and width / Länge und Breite / Longueur et largeur Spessore Thickness / Stärke / Epaisseur Rettilineità lati Warpages of edges / Geradheit der Kanten / Rectitude des arêtes Ortogonalità Wedging / Rechtwinkligkeit / Orthogonalité Planarità Flatness / Planität / Planimétrie	ISO 10545.2	±0,6% (±2,00 mm) ±5% (±0,5 mm) ±0,5% (±1,5 mm) ±0,5% (±2,00 mm) ±0,5% (±2,00 mm)	Conforme In accordance Erfüllt Conforme	ASTM C-499 ASTM C-485 ASTM C-502	In accordance
	Assorbimento % d'acqua Water absorption Wasseraufnahme % Absorption d'eau %	ISO 10545.3	≤ 0,5%	Conforme In accordance Erfüllt Conforme	ASTM C-373	In accordance
	Resistenza alla flessione Bending strength Biegezugfestigkeit Résistance à la flexion	ISO 10545.4	Modulus of rupture (average): R ≥ 36N/mm ² Breaking strength for thickness ≥ 7,5 mm S > 1300 N	Conforme In accordance Erfüllt Conforme	ASTM C-648 250 LBS or greater	In accordance
	Dilatazione termica lineare tra 20° e 100° C Linear thermal expansion between 20° and 100° C Lineare Wärmeausdehnung zwischen 20° und 100° C Dilatation thermique linéaire entre 20° et 100° C	ISO 10545.8	Secondo i dati del costruttore According to builder's specifications Lautangaben des Herstellers Selon les éléments du constructeur	≈ 7x10 ⁻⁴ C ⁻¹		
	Resistenza agli sbalzi termici Thermal shock resistance Temperaturwechselbeständigkeit Résistance aux écarts de température	ISO 10545.9	Richiesta Request Bitte Demande	Resistente Resistant Widerstehend Résistant		
	Resistenza al gelo Frost resistance Frostbeständigkeit Résistance au gel	ISO 10545.12	Richiesta Request Bitte Demande	Resistente Resistant Widerstehend Résistant	ASTM C-1026	In accordance
	Resistenza all'attacco chimico Resistance to chemical attack Beständigkeit gegen Chemikalien Résistance à l'attaque chimique	ISO 10545.13	Secondo i dati del costruttore According to builder's specifications Lautangaben des Herstellers Selon les éléments du constructeur	Resistente Resistant Widerstehend Résistant	ASTM C-650	In accordance
	Resistenza dei colori alla luce Colours resistance to light Lichtbeständigkeit Résistance des couleurs à la lumière	DIN 51094	Nessuna alterazione No alteration Keine Veränderung Aucune altération	Conforme In accordance Erfüllt Conforme		
	Resistenza alle macchie Stain resistance Fleckenfestigkeit Résistance aux taches	ISO 10545.14	≥ Classe 3 Metodo di prova disponibile Test method available Verfügbare prüfmethod Méthode d'essai disponible	Conforme In accordance Erfüllt Conforme		
	Resistenza allo scivolamento Slippage resistance Rutschsicherheit Résistance au glissement Pendulum slip test	DIN 51130 * DIN 51097 * BS EN 7976-2*	9 ≤ R ≤ 13 A,B,C > 36 Dry > 36 Wet	NATURALE R10 LEVIGATO ANTISLIP R11 NATURALE A LEVIGATO ANTISLIP A+B+C NATURALE LEVIGATO ANTISLIP	ASTM C-1028 * COF ≥ 0,6 Dry ≥ 0,6 Wet ANSI * 137.1-2012 DCOF > 0,42 Wet AS 4586: 2013 CLASS	NATURALE LEVIGATO ANTISLIP NATURALE LEVIGATO ANTISLIP NATURALE LEVIGATO ANTISLIP

*Trattandosi di normative nazionali, i metodi di prova, i requisiti e le classificazioni variano da paese a paese. Il valore atteso dalla resistenza allo scivolamento della produzione di Industrie Ceramiche Piemme S.p.a., può variare in base al lotto produttivo. Specifica documentazione è disponibile su richiesta. ELENCO DELLE SERIE CERTIFICATE E CLASSIFICAZIONI DISPONIBILI A RICHIESTA.
 Test methods, requirements and classifications differ from country to country, according to the national regulations. The expected value of slippage resistance of products by Industrie Ceramiche Piemme S.p.a. may vary depending on the production batch. Specific documents are available upon request. LIST OF CERTIFIED SERIES AND CLASSIFICATIONS AVAILABLE UPON REQUEST.
 Prüfverfahren, Erfordernisse und Klassifikationen sind verschieden von Land zu Land, gemäß der nationalen Vorschriften. Der Erwartungswert der Rutschsicherheit der Produkte von Industrie Ceramiche Piemme S.p.a. kann sich - je nach der Produktionspartie - verändern. Spezifische Unterlagen sind auf Verlangen zur Verfügung. LISTE DER GEPRÜFTEN SERIE UND KLASSEFIZIERUNGEN AUF ANFRAGE ERHÄLTICH.
 Les méthodes d'essai, les réquisitions et les classifications changent de pays à pays, selon les réglementations nationales. La valeur attendue de résistance au glissement des produits de Industrie Ceramiche Piemme S.p.a. peut varier en fonction du lot de production. Une documentation spécifique est disponible sur demande. LISTE DES SERIES CERTIFIÉES ET DES CLASSEMENTS DISPONIBLES SUR DEMANDE.

CONCERNANT LA NORME UPEC, VEUILLEZ SVP VERIFIER DIRECTEMENT SUR INTERNET EN TAPANT "UPEC PIEMME" LES REFERENCES ET/OU FINITIONS EVENTUELLEMENT PAS ENCORE A CE JOUR CERTIFIEES.



CERAMICHEPIEMME
FLOOR AND MORE



Norme per la posa e la manutenzione

Installation and maintenance instructions - Verlegung, reinigung und pflege
 Guide a la pose et l'entretien

<ul style="list-style-type: none"> - Per i prodotti rettificati consigliamo una fuga di 2 mm per un migliore risultato di posa. - Per una migliore resa estetica Piemme consiglia stuccature colorate in tinta con le piastrelle. - Verificare, prima dell'utilizzo, la compatibilità ed idoneità dei riempitivi per fughe con il prodotto ceramico. - Rimuovere le eccedenze dei riempitivi per fughe quando gli stessi sono ancora freschi. - Attenersi scrupolosamente alle istruzioni indicate dai produttori dei riempitivi per fughe. - Per eliminare completamente i residui di posa, che potrebbero compromettere la manutenzione ordinaria e le caratteristiche del prodotto, a posa ultimata, procedere con la pulizia utilizzando prodotti adeguati, a base Acida max 3%, rispettando le indicazioni del produttore. Osservare assolutamente i limiti di tempo indicati nelle istruzioni: un contatto troppo prolungato con questi prodotti potrebbe provocare il danneggiamento della superficie. - Gli eventuali aloni che si dovessero presentare dopo la posa di materiali lappati o levigati si potranno facilmente eliminare utilizzando un prodotto idoneo, a base Alcalina. - Riguardo l'utilizzo di materiali ceramici all'esterno, pure riconfermando l'ingelività dei prodotti Piemme in gres porcellanato, in conformità alle vigenti normative europee EN 14411/ISO 13006-ISO 10545.12, occorre attenersi ad alcune fondamentali norme previste per la posa all'esterno, atte a rendere inattaccabili al gelo i predetti pavimenti. Le condizioni più importanti da rispettare sono: le opportune pendenze, le impermeabilizzazioni, i giunti di dilatazione, e l'uso di idonei materiali per la posa. - Decorazioni realizzati con smalti e metalli preziosi E' indispensabile proteggere la superficie durante la posa, non utilizzare assolutamente prodotti abrasivi e/o acidi, ma solo acqua e sapone neutro. Il produttore non risponde di eventuali danni a questi preziosi materiali causati da "sfregamenti" durante la posa in opera. Per nessun motivo saranno accettate contestazioni relative a materiale posato. 	<p>TIPO DI SPORCO</p> <p>Birra - Caffè - Gelato - Vino Gomma Pneumatico - Grassi vegetali e animali - Inchiostri - Lampositi Olii Meccanici - Residui di scotch Olio di lino - Pennarello - Resine Smalti - Tintura per capelli</p> <p>Cera protettiva anti-abrasione Depositi calcarei Macchie di ruggine</p> <p>Cera di candela Residui di scotch</p> <p>Per ulteriori informazioni specifiche consultare l'area tecnica sul sito Piemme: www.ceramichepiemme.it</p>	<p>INDICAZIONI PER LA PULIZIA</p> <p>Prodotti a Base Alcalina</p> <p>Prodotti a Base Acida</p> <p>Solventi</p>
<ul style="list-style-type: none"> - For better installation results of rectified products, we suggest 2 mm joint. - For a better aesthetic finish, Piemme recommends using jointing colours that match the tiles. - Please check, before using, the compatibility and suitability of grouting material with the ceramic tile. - Clean away the excess of grouting materials while they are still fresh. - Follow carefully the instructions pointed out by the producers of tile grouting materials. - To completely eliminate installation residues, which could negatively affect routine maintenance and product characteristics once installation has terminated, proceed to clean using adequate products, with max. 3% Acid base, following the manufacturer's instructions. Always closely abide by the time limits indicated in the instructions: prolonged contact with these products may cause damage to the surface. - Any rims that appear after installing lapped or polished materials can be easily eliminated using a suitable Alkaline-based product. - With regard to the use of ceramic materials outdoors, while once more reiterating that Piemme porcelain stoneware products are frost-proof, in compliance with applicable European standards EN 14411/ISO 13006-ISO 10545.12, a number of fundamental procedures must be followed for outdoor installation, suitable for making the aforementioned floors resistant to frost. The most important aspects are: suitable gradients, waterproofing, expansion joints, and the use of suitable installation materials. - Decorations made with glazes and precious metals It is most important to protect the surface during installation. Never use abrasive and/or acid products, only water and neutral soap. The manufacturer disclaims liability in case of any damage to these precious materials caused by "rubbing" during installation. Under no circumstances will disputes be accepted relating to the installed material. 	<p>TYPE OF STAIN</p> <p>beer - coffee - wine - ice cream vegetable and animal fats - rubber remains of scotch tape - grease from machines - linseed oil - felt tip pens - paints - inks - hair dye</p> <p>protective anti-abrasion wax calcareous residuals rust stains</p> <p>candle wax remains of scotch-tape</p> <p>For further specific details please visit the technical area on Piemme website: www.ceramichepiemme.it</p>	<p>CLEANING SUGGESTIONS</p> <p>Alkaline-based detergent</p> <p>Acid-based detergent</p> <p>Solvent</p>
<ul style="list-style-type: none"> - Damit sich eine bessere Verlegung von geschliffenen Produkten ergibt, empfehlen wir eine Fugenbreite von 2 mm. - Für ein optisch perfektes Ergebnis empfiehlt Piemme, die Fugen farblich auf die Fliesen abzustimmen. - Prüfen sie bitte, vor der Verwendung, die Zweckmäßigkeit und die Verträglichkeit des Fugenfüllmittels mit den Keramikfliesen. - Bitte entfernen sie das überflüssige Fugenfüllmittel wenn es noch frisch ist. - Folgen sie bitte sorgfältig die von dem Herstellern des Fugenfüllmittels angegebenen Bedienungsvorschriften. - Zur vollkommenen Entfernung der Verlegerückstände, die die normale Pflege erschweren und die Merkmale des Produkts beeinträchtigen könnten, nach der Verlegung geeignete Reinigungsmittel auf max. 3% Säurebasis verwenden und bei der Reinigung die Hinweise des Herstellers beachten. Die angegebenen Zeiten keinesfalls überschreiten: ein zu lange andauernder Kontakt mit diesen Produkten kann Beschädigungen der Oberfläche verursachen. - Eventuelle nach der Verlegung von geläpftem oder geschliffenem Material sichtbare Schleier lassen sich einfach mit entsprechenden, alkalischen Produkten entfernen. - Auch wenn die Piemme-Feinsteinzeugprodukte gemäß den europäischen Normen EN 14411/ISO 13006-ISO 10545.12 frostbeständig sind, müssen beim Einsatz keramischer Materialien im Freien einige Grundregeln beachtet werden, damit die Bodenbeläge nicht vom Frost angegriffen werden können. Die wichtigsten Voraussetzungen sind: korrektes Gefälle, Abdichtung, Dehnungsfugen sowie geeignetes Verlegematerial. - Dekore mit Glasuren und Edelmetallen Während der Verlegung muss die Oberfläche unbedingt abgedeckt werden. Es dürfen keine scheuernden und/oder säurehaltigen Produkte verwendet werden, sondern ausschließlich Wasser und neutrale Seife. Der Hersteller haftet nicht für eventuelle, während der Verlegung durch Abrieb entstandene Schäden an diesen hochwertigen Materialien. Reklamationen von bereits verlegtem Material werden in keinem Fall akzeptiert. 	<p>VERSCHMUTZUNGSART</p> <p>Bier - Wein - Eis - Kaffee Tierische oder pflanzliche Fette Gummi - Kleberbandresten Schmieröl - Tinte - Leöl - Filzstift - Harz oder Lack - Haarfarbe</p> <p>Kratzenschutz-Wachs Kalkablagerungen Rostflecken</p> <p>Kerzenwachs Kleberbandresten</p> <p>Weitere Einzelheiten finden Sie in dem technischen Bereich des Piemme Website: www.ceramichepiemme.it</p>	<p>REINIGUNGSHINWEISE</p> <p>Alkalische Reinigungsmittel</p> <p>Säure-Reinigungsmittel</p> <p>Lösungsmittel</p>
<ul style="list-style-type: none"> - Pour obtenir le meilleur résultat de pose de produits rectifiés, il est conseillé de réaliser un joint de 2 mm. - Pour parfaire l'effet esthétique obtenu, Piemme conseille de confectionner des joints de la même couleur que les carreaux. - Vérifier avant la pose la compatibilité et convenance des remplissages pour joints avec le produit céramique. - Enlever les surplus des remplissages pour joints alors qu'ils sont encore frais. - Respecter scrupuleusement les instructions indiquées par les fabricants de remplissages pour joints. - Pour éliminer complètement tout résidu de pose pouvant gêner l'entretien courant et altérer les caractéristiques du produit, il est conseillé, à la fin de la pose, de procéder au nettoyage du carrelage avec des produits à base acide maximum 3% et de respecter les consignes du fabricant. Suivre impérativement les délais indiqués dans la notice car le contact trop prolongé de ces produits pourrait endommager la surface. - Pour éliminer facilement la présence éventuelle de cernes après la pose de carreaux rodés ou polis, utiliser un produit à base alcaline. - Pour ce qui est de la pose à l'extérieur, bien que les produits Piemme en grès cérame soient ingélifs, conformément aux normes européennes EN 14411/ISO 13006-ISO 10545.12, il convient cependant de respecter quelques règles fondamentales de manière à rendre le carrelage inattaquable au gel. Les conditions les plus importantes à remplir sont: le degré d'inclinaison, l'imperméabilisation, les joints de dilatation et l'utilisation de matériaux de pose appropriés. - Décorés réalisés avec des émaux et des métaux précieux Il est indispensable de protéger la surface pendant la pose. N'utiliser en aucun cas des produits abrasifs et/ou acides mais uniquement de l'eau et du savon neutre. Le fabricant ne répond pas des dommages éventuels de ces matériaux précieux causés par le frottement pendant la pose. Aucune réclamation, quelle qu'elle soit, concernant le matériau posé ne sera acceptée. 	<p>TYPE DE TACHE</p> <p>Bière - Vin - Glace - Café - Graisses végétales et animales - Encres Résidus de scotch - Huile de graissage - Hile de lin Crayon feutre Emaux - Teinture pour cheveux Caoutchouc pour pneus</p> <p>Cire de protection anti abrasion Dépôts de calcaire Tache de rouille</p> <p>Cire de bougie Résidus de scotch</p> <p>Pour d'ultérieures informations spécifiques consulter le département technique du site Piemme: www.ceramichepiemme.it</p>	<p>NETTOYAGE CONSEIL</p> <p>Détergents à base alcaline</p> <p>Détergents à base d'acide</p> <p>Solvant</p>

Voci di capitolato

Specifications - Technische Beschreibung - Caractéristiques

GRES FINE PORCELLANATO AD IMPASTO COLORATO Superficie ceramica formata da un supporto compatto derivato da una miscela di pregiati minerali e decorato in superficie con smalti particolarmente resistenti. Resistente agli sbalzi termici, al gelo, all'attacco degli acidi e delle basi e tecnologicamente avanzato, trova impiego in condizioni di traffico medio pesanti. In base alle norme UNI EN 14411, viene classificato nel gruppo Bla ed è conforme ai requisiti della norma UNI EN 14411-G.	Assorbimento d'acqua	ISO 10545.3	≤ 0,5%
	Resistenza alla flessione	ISO 10545.4	≥ 35N/mm ²
	Resistenza all'attacco chimico	ISO 10545.13.14	Resistente
	Resistenza al gelo	ISO 10545.12	Resistente
	Resistenza agli sbalzi termici	ISO 10545.9	Resistente
	Resistenza dei colori alla luce	DIN 51094	Conforme
	Resistenza allo scivolamento	DIN 51130	R11 (velvet)

COLOURED-BODY FINE PORCELAIN STONEWARE Ceramic surface consisting of a compact substrate made of a mix of precious materials and decorated on surface with particularly resistant glazes. Resistant against heat fluctuations, frost, acid and base attack, and technologically advanced, it is ideal for use in medium-heavy traffic situations. According to UNI EN 14411 standards, it is classified in the Bla group and complies with UNI EN 14411-G standard requirements.	Water absorption	ISO 10545.3	≤ 0,5%
	Bending strength	ISO 10545.4	≥ 35N/mm ²
	Resistance to chemical attack	ISO 10545.13.14	Resistant
	Frost resistance	ISO 10545.12	Resistant
	Thermal shock resistance	ISO 10545.9	Resistant
	Colours resistance to light	DIN 51094	In accordance
	Slippage resistance	DIN 51130	R11 (velvet)

FEINSTEINZEUG AUS FARBIGER MASSE Keramikoberfläche mit einer kompakten Unterlegplatte aus einer Mischung hochwertiger Mineralstoffe und mit besonders beständigen Glasuren dekorierter Oberfläche. Beständig gegen Temperaturschocks, Frost, Säuren und Laugen sowie technologisch ausgereift für den Einsatz in mittlerem bis hohem Verkehr ausgesetzten Bereichen. Entspricht den Normen UNI EN 14411, zur Gruppe Bla gehörig und den Voraussetzungen der Norm UNI EN 14411-G konform.	Wasseraufnahme	ISO 10545.3	≤ 0,5%
	Biegezugfestigkeit	ISO 10545.4	≥ 35N/mm ²
	Beständigkeit gegen Chemikalien	ISO 10545.13.14	Widerstehend
	Frostbeständigkeit	ISO 10545.12	Widerstehend
	Temperaturwechselbeständigkeit	ISO 10545.9	Widerstehend
	Lichtbeständigkeit	DIN 51094	Erfüllt
	Rutschsicherheit	DIN 51130	R11 (velvet)

GRÈS CÉRAME FIN À PÂTE COLORÉE Surface céramique formée d'un tesson compact issu d'un mélange de minéraux précieux; décor réalisé en surface avec des émaux particulièrement résistants. Résistance aux écarts thermiques, au gel, à l'attaque des acides et des bases. Matériau obtenu grâce à des technologies de pointe dont l'utilisation est indiquée en cas de passage moyennement intense. Aux termes des normes UNI EN 14411, ce matériau est classé dans le groupe Bla et il est conforme aux exigences de la norme UNI EN 14411-G.	Absorption d'eau	ISO 10545.3	≤ 0,5%
	Résistance à la flexion	ISO 10545.4	≥ 35N/mm ²
	Résistance à l'attaque chimique	ISO 10545.13.14	Résistant
	Résistance au gel	ISO 10545.12	Résistant
	Résistance aux écarts de température	ISO 10545.9	Résistant
	Résistance des couleurs à la lumière	DIN 51094	Conforme
	Résistance au glissement	DIN 51130	R11 (velvet)

Gennaio 2021

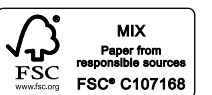

FSC® è una certificazione che consente al consumatore finale di riconoscere i prodotti fabbricati con materie prime che vengono da foreste gestite in modo responsabile anche dal punto di vista sociale.

FSC® is a certification that allows the consumer to identify products manufactured with raw materials from forests that are managed responsibly from the point of view of society.

CERAMICHE **PIEMME**
FLOOR AND MORE

INDUSTRIE CERAMICHE PIEMME S.P.A.

VIA DEL CROCIALE 42/44 - 41042 FIORANO (MO) - ITALY
TEL. +39 0536.849111 - FAX +39 0536.849402
WWW.CERAMICHEPIEMME.IT - INFO@CERAMICHEPIEMME.IT



Purestone

Una vera e propria materia d'arredo, ricavata elaborando l'estetica di diverse pietre esistenti in natura. "Purestone" Piemme è un moderno grès porcellanato dai toni delicati e dalle venature discrete, mai eccessive.

A real furnishing material, obtained by processing the aesthetics of various kinds of natural stones, Piemme "Purestone" is a modern porcelain stoneware with delicate colour shades and discreet and never excessive veins.

Ein echtes Einrichtungsmaterial, gewonnen aus einem Mix der Optik verschiedener Natursteine. Piemme "Purestone" ist ein modernes Feinsteinzeug in zarten Tönen und mit dezenten, unaufdringlichen Aderungen.

Cette véritable révolution en matière d'architecture intérieure est le fruit d'une étude précise sur les différentes pierres existant dans la nature. "Purestone" by Piemme est un grès cérame moderne, aux teintes délicates, aux veines discrètes parfaitement dosées.

5

Colori
Colours
Farben
Couleurs



4

Formati
Sizes
Formate
Formats

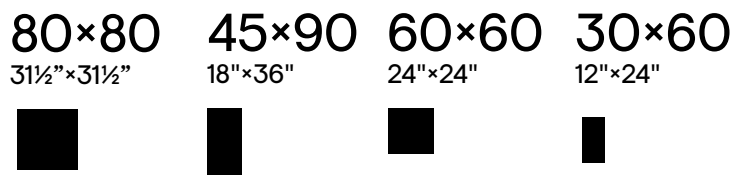

2

Spessori
Thickness
Stärke
Epaisseur

▽ 9,5 ▽ 10,5

4

Superfici
Surfaces
Oberflächen
Surfaces

Naturale Levigato Velvet Hammered

3

Strutture 3D
3D structures
Strukturen
Decorations and relief



i

Effetto Pietra
Stone Look
Natursteinoptik
Effet Pierre

Rivestimento
Wall Tiles
Wandfliesen
Revêtement

Pavimento
Floor Tiles
Bodenfliesen
Sol

Gres fine porcellanato ad impasto colorato
Coloured-body fine porcelain stoneware
Feinsteinzeug aus farbiger Masse
Grès cérame fin à pâte colorée

Tecnologia digitale
Digital technology
Digital Technologie
Technologie numérique

Purestone





Purestone



Bianco

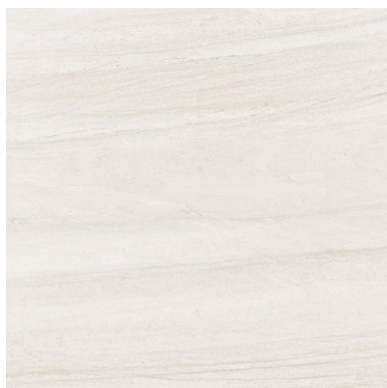

± 10,5

80×80

28660 | Purestone bianco nat/ret
54600 | Purestone bianco lev/ret



± 9,5

60×60

10810 | Purestone bianco nat
10840 | Purestone bianco nat/ret
10870 | Purestone bianco lev/ret



± 10,5

45×90

01118 | Purestone bianco nat/ret
01123 | Purestone bianco lev/ret
00508* | Purestone bianco lev/ret

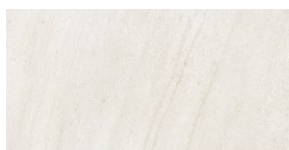

± 9,5

30×60

10960 | Purestone bianco nat
10990 | Purestone bianco nat/ret
11080 | Purestone bianco lev/ret



± 9,5

30×60

52780 | Purestone bianco hammered



30×60

00535 | Purestone linea bianco nat/ret



30×60

11160 | Purestone muretto bianco nat/ret



30×60

00530 | Purestone bianco velvet ret



30×30

39590 | Purestone mosaico bianco nat/ret

* Attenzione: l'imballo del formato 45×90 può essere da 2 o 3 pezzi. Verificare in fase di ordine. / *Attention: the packing of size 45×90 could be 2 pieces in box or 3 pieces in box. Kindly check while ordering.
*Achtung: die Verpackungen vom Format 45×90 können entweder 2 oder 3 Stk. enthalten. Bitte prüfen Sie es bei jeder Bestellung. / *Attention: le conditionnement du format 45×90 peut être de 2 ou 3 pièces par boîte. Merci de vérifier en phase de commande s'il vous plait.

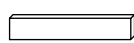
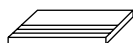

Purestone



Beige



± 10,5

80×80

28680 | Purestone Beige Nat/Ret
54610 | Purestone Beige Lev/Ret



± 9,5

60×60

10820 | Purestone Beige Nat
10850 | Purestone Beige Nat/Ret
10880 | Purestone Beige Lev/Ret

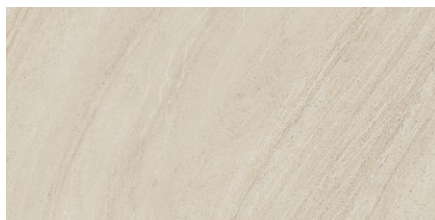

± 10,5

45×90

01119 | Purestone Beige Nat/Ret
01124 | Purestone Beige Lev/Ret
00504* | Purestone Beige Nat/Ret
00509* | Purestone Beige Lev/Ret



± 9,5

30×60

10970 | Purestone Beige Nat
11000 | Purestone Beige Nat/Ret
11140 | Purestone Beige Lev/Ret



± 9,5

30×60

52790 | Purestone Beige Hammered

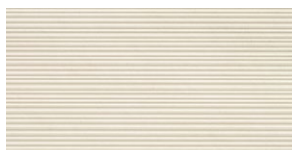

30×60

00536 | Purestone Linea Beige Nat/Ret



30×60

11300 | Purestone Muretto Beige Nat/Ret



30×60

00531 | Purestone Beige Velvet Ret



30×30

39600 | Purestone Mosaico Beige Nat/Ret

* Attenzione: l'imballo del formato 45×90 può essere da 2 o 3 pezzi. Verificare in fase di ordine. / *Attention: the packing of size 45×90 could be 2 pieces in box or 3 pieces in box. Kindly check while ordering.
*Achtung: die Verpackungen vom Format 45×90 können entweder 2 oder 3 Stk. enthalten. Bitte prüfen Sie es bei jeder Bestellung. / *Attention: le conditionnement du format 45×90 peut être de 2 ou 3 pièces par boîte. Merci de vérifier en phase de commande s'il vous plait.

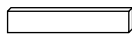
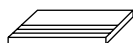

Purestone



Grigio



± 10,5

80×80

28700 | Purestone Grigio Nat/Ret
54620 | Purestone Grigio Lev/Ret



± 9,5

60×60

10830 | Purestone Grigio Nat
10860 | Purestone Grigio Nat/Ret
10890 | Purestone Grigio Lev/Ret



± 10,5

45×90

01120 | Purestone Grigio Nat/Ret
01125 | Purestone Grigio Lev/Ret
00510* | Purestone Grigio Lev/Ret



± 9,5

30×60

10980 | Purestone Grigio Nat
11070 | Purestone Grigio Nat/Ret
11150 | Purestone Grigio Lev/Ret



± 9,5

30×60

53130 | Purestone Grigio Hammered



30×60

00537 | Purestone Linea Grigio Nat/Ret



30×60

11310 | Purestone Muretto Grigio Nat/Ret



30×60

00532 | Purestone Grigio Velvet Ret



30×30

39610 | Purestone Mosaico Grigio Nat/Ret

* Attenzione: l'imballo del formato 45×90 può essere da 2 o 3 pezzi. Verificare in fase di ordine. / *Attention: the packing of size 45×90 could be 2 pieces in box or 3 pieces in box. Kindly check while ordering.
*Achtung: die Verpackungen vom Format 45×90 können entweder 2 oder 3 Stk. enthalten. Bitte prüfen Sie es bei jeder Bestellung. / *Attention: le conditionnement du format 45×90 peut être de 2 ou 3 pièces par boîte. Merci de vérifier en phase de commande s'il vous plait.

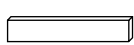
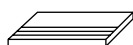

Purestone

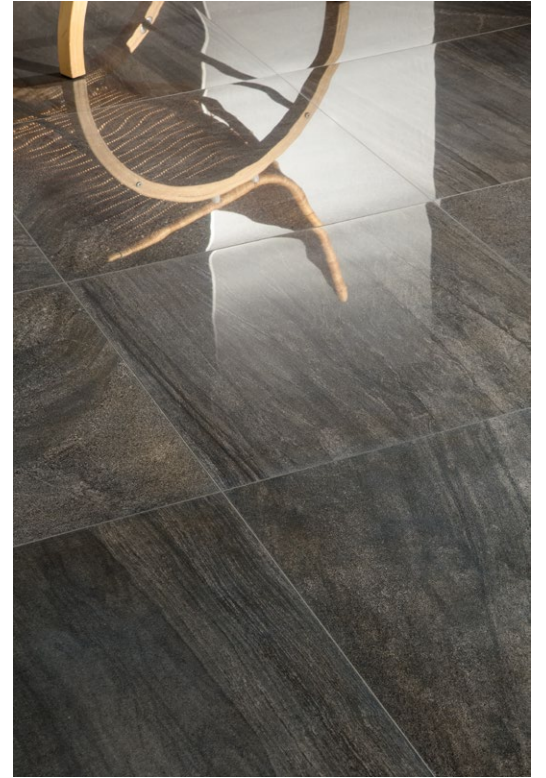

Antracite



± 10,5

80×80

00514 | Purestone Antracite Nat/Ret
00516 | Purestone Antracite Lev/Ret



± 9,5

60×60

00518 | Purestone Antracite Nat
00521 | Purestone Antracite Nat/Ret
00523 | Purestone Antracite Lev/Ret

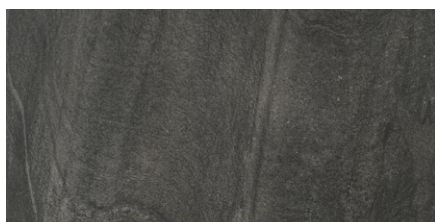

± 10,5

45×90

01122 | Purestone Antracite Nat/Ret
01127 | Purestone Antracite Lev/Ret
00507* | Purestone Antracite Nat/Ret
00512* | Purestone Antracite Lev/Ret

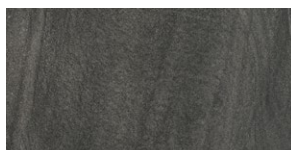

± 9,5

30×60

00525 | Purestone Antracite Nat
00527 | Purestone Antracite Nat/Ret
00529 | Purestone Antracite Lev/Ret



30×60

00539 | Purestone Linea Antracite Nat/Ret



30×60

00725 | Purestone Muretto Piombo/ Antracite Nat/Ret



30×60

00534 | Purestone Antracite Velvet Ret

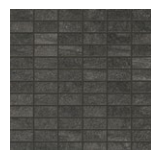

30×30

00541 | Purestone Mosaico Antracite Nat/Ret

* Attenzione: l'imballo del formato 45×90 può essere da 2 o 3 pezzi. Verificare in fase di ordine. / *Attention: the packing of size 45×90 could be 2 pieces in box or 3 pieces in box. Kindly check while ordering.
*Achtung: die Verpackungen vom Format 45×90 können entweder 2 oder 3 Stk. enthalten. Bitte prüfen Sie es bei jeder Bestellung. / *Attention: le conditionnement du format 45×90 peut être de 2 ou 3 pièces par boîte. Merci de vérifier en phase de commande s'il vous plait.

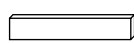
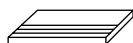

Purestone



Piombo



± 10,5

80×80

00513 | Purestone Piombo Nat/Ret
00515 | Purestone Piombo Lev/Ret



± 9,5

60×60

00517 | Purestone Piombo Nat
00519 | Purestone Piombo Nat/Ret
00522 | Purestone Piombo Lev/Ret



± 10,5

45×90

01121 | Purestone Piombo Nat/Ret
01126 | Purestone Piombo Lev/Ret
00506* | Purestone Piombo Nat/Ret
00511* | Purestone Piombo Lev/Ret

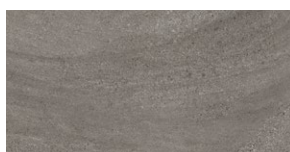

± 9,5

30×60

00524 | Purestone Piombo Nat
00526 | Purestone Piombo Nat/Ret
00528 | Purestone Piombo Lev/Ret



30×60

00538 | Purestone Linea Piombo Nat/Ret



30×60

00725 | Purestone Muretto Piombo/ Antracite Nat/Ret



30×60

00533 | Purestone Piombo Velvet Ret

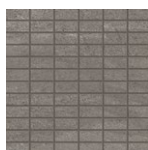

30×30

00540 | Purestone Mosaico Piombo Nat/Ret

* Attenzione: l'imballo del formato 45×90 può essere da 2 o 3 pezzi. Verificare in fase di ordine. / *Attention: the packing of size 45×90 could be 2 pieces in box or 3 pieces in box. Kindly check while ordering.
*Achtung: die Verpackungen vom Format 45×90 können entweder 2 oder 3 Stk. enthalten. Bitte prüfen Sie es bei jeder Bestellung. / *Attention: le conditionnement du format 45×90 peut être de 2 ou 3 pièces par boîte. Merci de vérifier en phase de commande s'il vous plait.

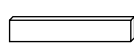
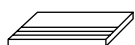







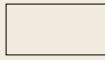

Purestone

Fasce di prezzo

Price range
Preisgruppe
Niveau de prix

■ Fascia prezzo al metro quadro
Square meter price range
Quadratmeter preisgruppe
Niveau de prix au mètre carré

▲ Fascia prezzo al pezzo
Price range per piece
Stück preisgruppe
Niveau de prix à la piece

	Formati Sizes	   							Strutture 3D 3D Structures		
		80×80 31½"×31½"	45×90 18"×36"	60×60 24"×24"	30×60 12"×24"	DIN 51130	DIN 51097	DCOF	Linea 30×60 12"×24"	Muretto 30×60 12"×24"	Velvet 30×60 12"×24"
		± 10,5	± 10,5	± 9,5	± 9,5				± 9,5	± 9,5	± 9,5
 Bianco	Nat			10810	570	10960	430				
	Nat/Ret	28660	740	01118	640	10840	630	10990	530		
	Lev/Ret	54660	770	01123 00508*	710	10870	750	11080	750		
	Velvet/Ret							00530	580		
	Hammered							52780	440		
 Beige	Nat			10820	570	10970	430				
	Nat/Ret	28680	740	01119 00504*	640	10850	630	11000	530		
	Lev/Ret	54610	770	01124 00509*	710	10880	750	11140	750		
	Velvet/Ret							00531	580		
	Hammered							52790	440		
 Grigio	Nat			10830	570	10980	430				
	Nat/Ret	28700	740	01120	640	10860	630	11070	530		
	Lev/Ret	54620	770	01125 00510*	710	10890	750	11150	750		
	Velvet/Ret							00532	580		
	Hammered							53130	440		
 Piombo	Nat			00517	570	00524	430				
	Nat/Ret	00513	740	01121 00506*	640	00519	630	00526	530		
	Lev/Ret	00515	770	01126 00511*	710	00522	750	00528	750		
	Velvet/Ret							00533	580		
 Antracite	Nat			00518	570	00525	430				
	Nat/Ret	00514	740	01122 00507*	640	00521	630	00527	530		
	Lev/Ret	00516	770	01127 00512*	710	00523	750	00529	750		
	Velvet/Ret							00534	580		



* Attenzione: l'imballo del formato 45×90 può essere da 2 o 3 pezzi. Verificare in fase di ordine.
Attention: the packing of size 45×90 could be 2 pieces in box or 3 pieces in box. Kindly check while ordering.
Achtung: die Verpackungen vom Format 45×90 können entweder 2 oder 3 Stk. enthalten. Bitte prüfen Sie es bei jeder Bestellung.
Attention: le conditionnement du format 45×90 peut être de 2 ou 3 pièces par boîte. Merci de vérifier en phase de commande s'il vous plait.

Purestone

Fasce di prezzo

Price range
Preisgruppe
Niveau de prix







- Fascia prezzo al metro quadro
Square meter price range
Quadratmeter preisgruppe
Niveau de prix au mètre carré
- ▲ Fascia prezzo al pezzo
Price range per piece
Stück preisgruppe
Niveau de prix à la pièce

Formati Sizes	Mosaico 30x30 (Su Rete) 12"x12" 1"x2" Dot	Pezzi Speciali Special Pieces			
					
		30x30 (Su Rete) 12"x12" 1"x2" Dot	Battiscopa 8x80* 3 1/8"x31 1/2"	Battiscopa 8x60 3 1/8"x24"	Gradino 30x60 12"x24"
	9,5	10,5	9,5	9,5	
Bianco	Nat			11320 ▲70	11390 ▲140
	Nat/Ret	39590 ▲190	33390 ▲100	71980 ▲80	
	Lev/Ret			72010 ▲130	
Beige	Nat			11330 ▲70	11400 ▲140
	Nat/Ret	39600 ▲190	34100 ▲100	71990 ▲80	
	Lev/Ret			72020 ▲130	
Grigio	Nat			11380 ▲70	11410 ▲140
	Nat/Ret	39610 ▲190	34110 ▲100	72000 ▲80	
	Lev/Ret			72030 ▲130	
Piombo	Nat			00542 ▲70	00550 ▲140
	Nat/Ret	00540 ▲190	00548 ▲100	00544 ▲80	
	Lev/Ret			00546 ▲130	
Antracite	Nat			00543 ▲70	00551 ▲140
	Nat/Ret	00541 ▲190	00549 ▲100	00545 ▲80	
	Lev/Ret			00547 ▲130	

*Disponibile su richiesta anche Lev/Ret
Polished and rectified finishes available on demand
Nach Anfrage auch poliert/kalibriert erhältlich
Sur demande disponible aussi en lev/rect

Imballi

Packing
Verpackung
Emballage

Formato / Size		± MM	 Pezzi/Scatola Pieces/Box Stck/Karton Carreaux/Boîte	 Mq/Scatola Sqmt/Box Qm/Karton M2/Boîte	 Kg/Scatola Kgs/Box Kg/Karton Kg/Boîte	 Scatole/Paletta Boxes/Pallet Karton/Pallet Boîte/Palette	 Mq/Paletta Sqmt/Pallet Qm/Pallet M2 /Palette	 Kg/Paletta Kgs/Pallet Kg/Pallet Kg/Palette	 Formato Paletta Size Pallet Format Pallet Dim. Palette
80×80	P	10,5	2	1,28	31,5	40	51,2	1260	120×80×97
45×90	P	10,5	3	1,215	29	30	36,45	870	120×95×60
45×90*	P	10,5	2	0,81	19,5	40	32,4	780	115×95×60
60×60 Nat	P	9,5	3	1,08	23	40	43,2	920	120×80×75
60×60 Nat/Ret	P	9,5	3	1,08	21,5	40	43,2	860	120×80×75
60×60 Lev/Ret	P	9,5	3	1,08	22,5	40	43,2	900	120×80×75
30×60 Nat	P	9,5	6	1,08	22	48	51,84	1056	120×80×75
30×60 Nat/Ret	P	9,5	6	1,08	21,5	48	51,84	1032	120×80×75
30×60 Lev/Ret	P	9,5	6	1,08	22,5	48	51,84	1080	120×80×75
30×60 Hammared	P	9,5	6	1,08	22	48	51,84	1056	120×80×75
30×60 Velvet Ret	P	9,5	6	1,08	21,5	48	51,84	1032	120×80×75
30×60 Linea Nat/Ret	P	9,5	6	1,08	21,5	40	43,2	860	120×80×75
30×60 Muretto Ret	P	9,5	6	1,08	22,5	40	43,2	900	120×80×75
30×30 Mosaico (Su Rete)	P	9,5	5	0,45	8,5	60			
Pezzi Speciali / Special Pieces									
8×80 Battiscopa	P	10,5	7	0,448	11	65			
8×60 Battiscopa	P	9,5	10	0,48	11	72			
30×60 Gradino	P	9,5	6	1,08	22	48			

* Attenzione: l'imballo del formato 45×90 può essere da 2 o 3 pezzi. Verificare in fase di ordine.

Attention: the packing of size 45×90 could be 2 pieces in box or 3 pieces in box. Kindly check while ordering.

Achtung: die Verpackungen vom Format 45×90 können entweder 2 oder 3 Stk. enthalten. Bitte prüfen Sie es bei jeder Bestellung.

Attention: le conditionnement du format 45×90 peut être de 2 ou 3 pièces par boîte. Merci de vérifier en phase de commande s'il vous plait.

Purestone

Abbinamenti

Matchings
Passende Kombinationen
Coloris compatibles

Suggerimenti utili per l'abbinamento delle diverse collezioni Ceramiche Piemme tra di loro e spunti cromatici per valorizzare gli interni.

Tips for combining the various Ceramiche Piemme collections with one another and colour suggestions for enhancing interiors.

Praktische Tipps für die Kombination der verschiedenen Ceramiche Piemme-Kollektionen miteinander und Farbakzente zur Aufwertung der Innenräume.

Conseils utiles de coordination entre les différentes collections Ceramiche Piemme et suggestions chromatiques pour la mise en valeur de l'espace ambiant.

Colori
Colours

Bianco

Beige

Grigio

Piombo

Antracite



Abbinamenti
tra serie
Tile matchings

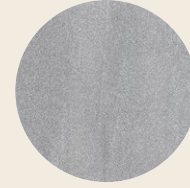

Abbinamenti
cromatici
Colour
matchings

