

MUSEUM

LAKESTONE

UNIQUE SURFACES

LAKESTONE, as its name indicates, is inspired by the stones found in lakes. This collection emulates an eye-catching sandstone, with a varying grainy appearance and colour. Its varying design brings a sense of movement to surfaces, combined with a neutral-coloured warmth synonymous with the natural world.

The tiles come in an All in One or Polished finish in a choice of three colours —Cloud, Oat and Dolphin— and wide assortment of formats: 75,5x151cm, 60x120cm, 90x90cm, 60x60cm, plus a 33x100cm wall tile model in a Natural finish.

LAKESTONE, como su nombre indica, está inspirada en las piedras que se obtienen en los lagos. Esta colección se caracteriza por ser una preciosa arenisca de grano variado en tamaño y color. Su gran diversidad gráfica aporta movimiento en conjunto, y una calidez neutra muy propia de la naturaleza.

Disponible en acabado All in One o Polished. En tres colores —Cloud, Oat y Dolphin— y con una gran variedad de formatos: 75,5x151cm, 60x120cm, 90x90cm, 60x60cm, y un revestimiento de 33x100cm en acabado Natural.

To see more details, [WATCH VIDEO](#)

STONE EFFECT

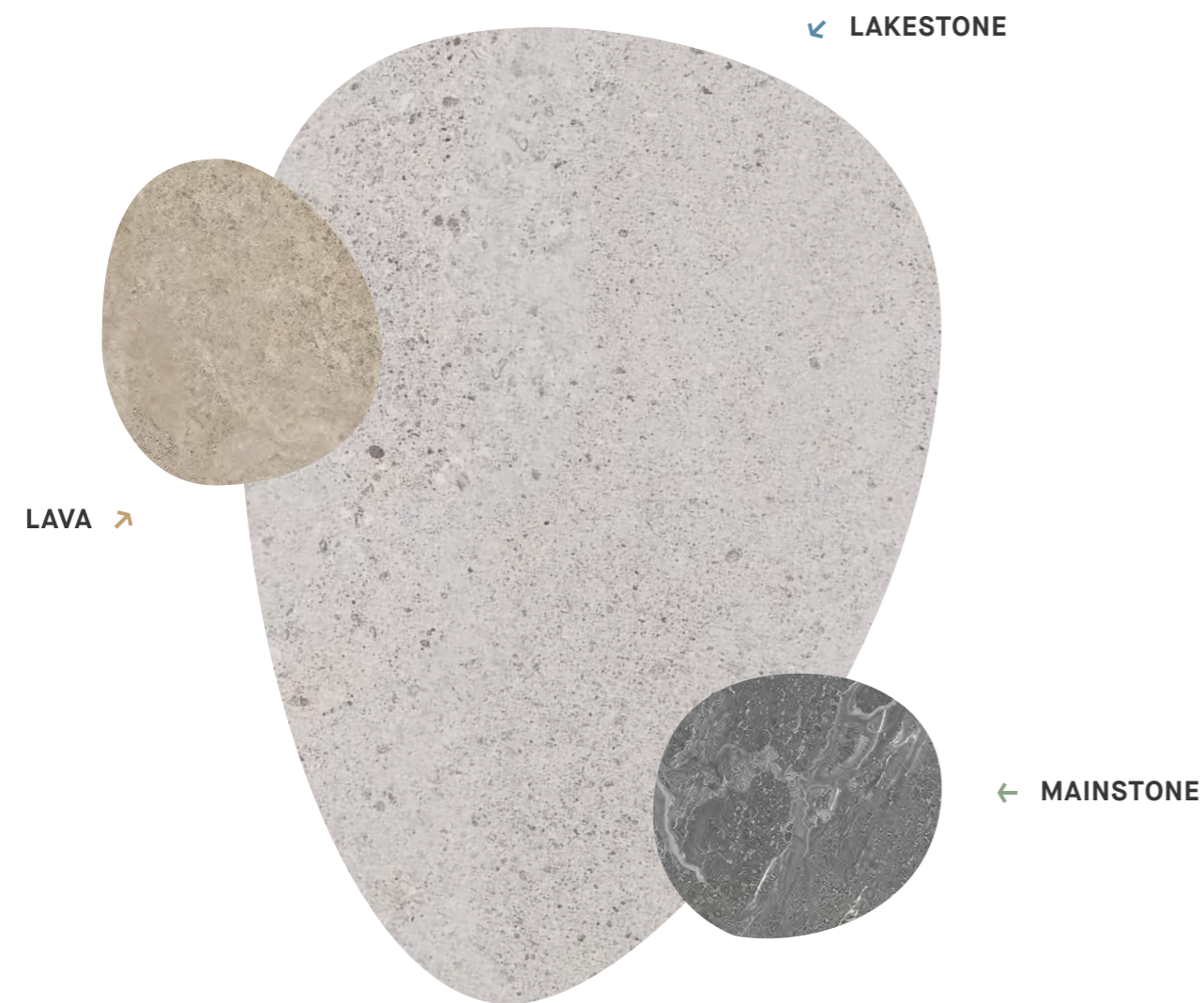

LAKESTONE, part of STONE EFFECT range

Unique natural-looking surfaces with a design evocative of natural minerals or rock. Industrially manufactured, without harming our precious natural environment.

LAKESTONE es parte de EFECTO PÉTREO

Superficies únicas de aspecto natural cuyo diseño deriva de una roca o mineral existente en la naturaleza. Obtenido industrialmente sin dañar la increíble naturaleza que nos rodea.

NEW FINISH

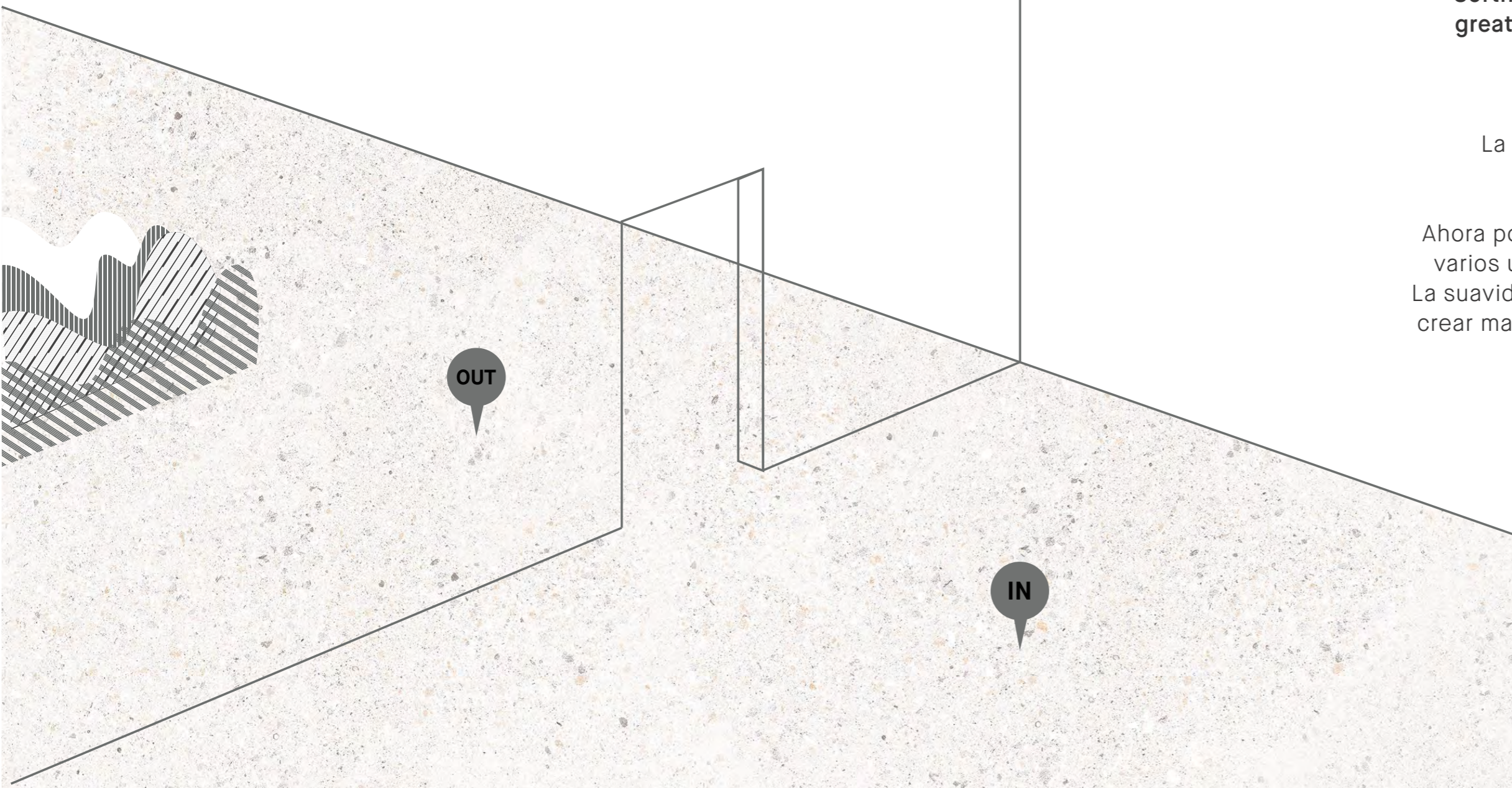

Innovation takes us to a new
ALL IN ONE concept.

Now we can use a single surface for several
applications both inside and outside a project.
Softness and anti-slip are unified to create
greater aesthetic continuity in the spaces.

La innovación nos traslada a un nuevo
concepto ALL IN ONE.

Ahora podemos utilizar una única superficie para
varios usos, tanto en interior como en exterior.
La suavidad y el antideslizamiento se unifican para
crear mayor continuidad estética en los espacios.



■ LAKESTONE OAT AS/75,5x151/C/R & CALACATTA EXTRA WHITE & SHERWOOD OAK PORTO

COMBINABILITY

LAKESTONE
collection



MARBLE

CALACATTA 4D
collection

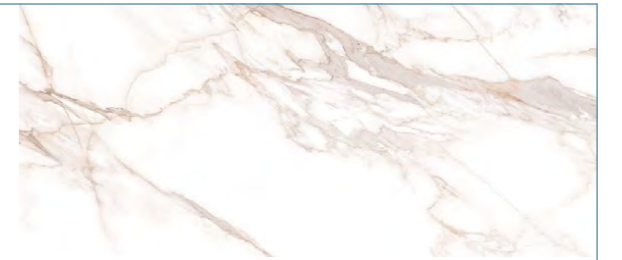

CRYSTAL
collection



STONE

LAVA
collection

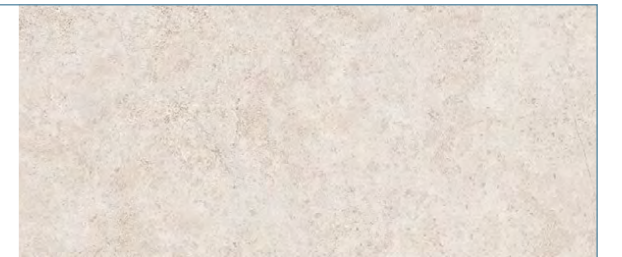

WOOD

SHERWOOD OAK 4D
collection





LAKESTONE CLOUD AS/75,5x151/C/R





LAKESTONE OAT AS/75,5x151/C/R





LAKESTONE OAT AS/75,5x151/C/R



Unique surface.

The aesthetic continuity both inside and outside a project is assured, thanks to the new All in One finish, where smoothness and anti-slip are unified.

Superficie única.

La continuidad estética tanto en el interior como en el exterior de un proyecto está asegurada, gracias al nuevo acabado All in One, donde la suavidad y el antideslizamiento se unifican.





LAKESTONE DOLPHIN/60x120/EP



Elegance.

Its beautiful sandstone graphics is enhanced by the Polished finish, which enhances the exquisiteness of the collection.

Elegancia.

Su bella gráfica de areniscas se ve potenciada gracias al acabado Polished, que realza la exquisitez propia de esta colección.

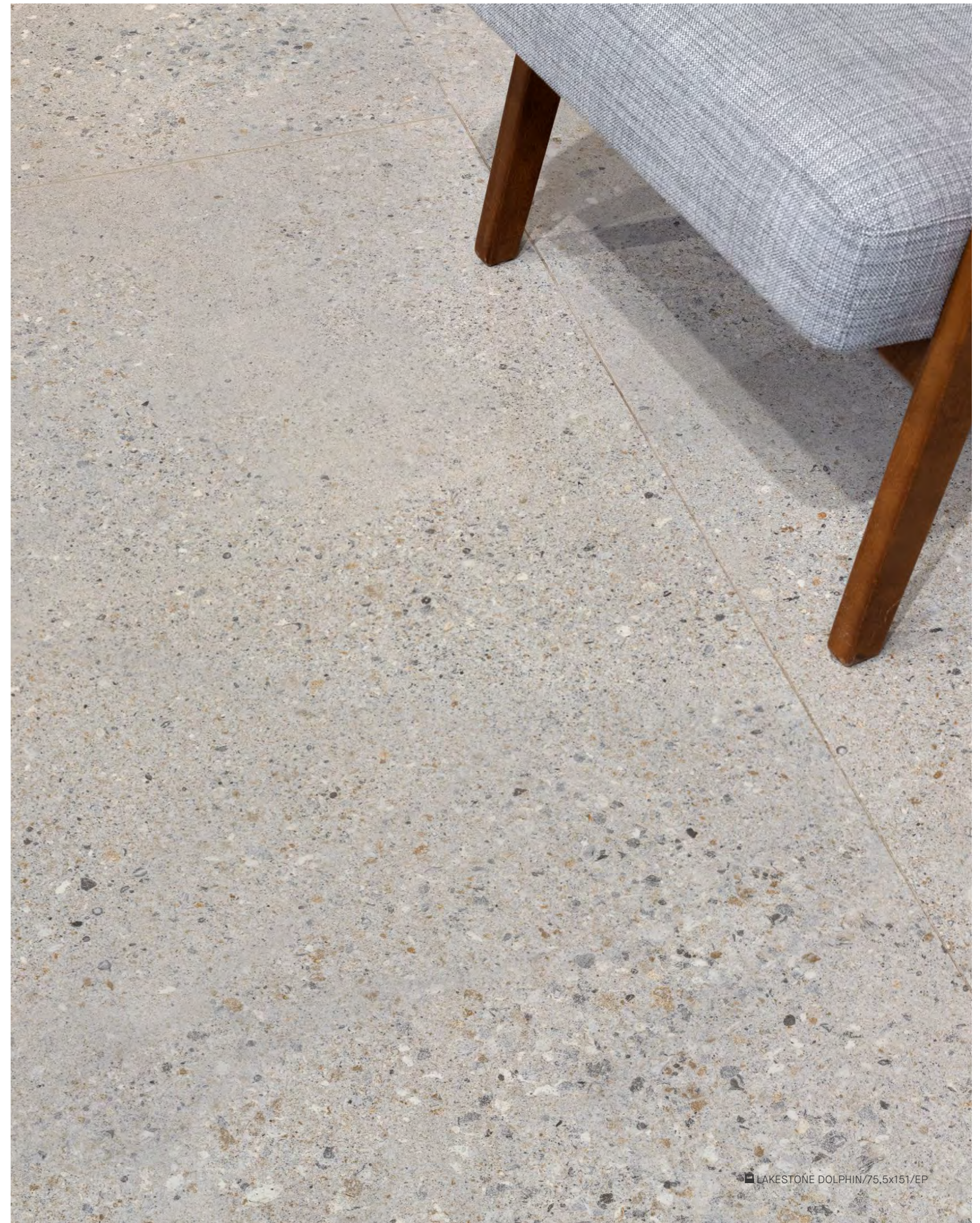

LAKESTONE DOLPHIN/75.5x151/EP



■ LAKESTONE CLOUD/90x90/EP ■ LAKESTONE CLOUD NT/33,3x100/R & LAKESTONE CLOUD DECOR/33,3x100/R



■ LAKESTONE CLOUD DECOR NT/33,3x100/R



Sophistication.

**The volume of its Diamond relief,
together with the sparkles of brilliance in the
sandstones, do not leave anyone indifferent.**

Sofisticación.

**La volumetría de su relieve Diamond junto con
los destellos de brillo en las areniscas,
no dejan indiferente a nadie.**



COLOURS

CLOUD



OAT



DOLPHIN



FINISHES

Porcelain ALL IN ONE (AS)









Porcelain POLISHED (EP)



White Body NATURAL (NT)

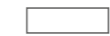

AVAILABLE FORMATS

		Porcelain			White Body		
							
		75,5x151 cm 29,7x59,5 "	60x120 cm 23,6x47,2 "	90x90 cm 35,4x35,4 "	60x60 cm 23,6x23,6 "	33,3x100 cm 13,1x39,4 "	33,3x100 cm 13,1x39,4 "
Thickness		10 mm		10 mm		10,5 mm	
Patterns		14		9		8	
Shade variation		V1		V1		V1	
CLOUD	All in One (AS)	28540 M92	28543 M91	28546 M81	28549 M98	-	-
	Polished (EP)	28552 M58	28555 M40	28558 M2	-	-	-
	Natural (NT)	-	-	-	-	28574 M82	28573 M83
OAT	All in One (AS)	28541 M92	28544 M91	28547 M81	28550 M98	-	-
	Polished (EP)	28553 M58	28556 M40	28559 M2	-	-	-
	Natural (NT)	-	-	-	-	28571 M82	28572 M83
DOLPHIN	All in One (AS)	28542 M92	28545 M91	28548 M81	28551 M98	-	-
	Polished (EP)	28554 M58	28557 M40	28560 M2	-	-	-

UPEC grant in process

COMPLEMENTARY PIECES

NEW Digital Stair Tread - Peldaño Escalera Digital (P.D)

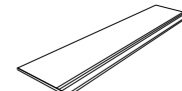
Shape	FINISHES	DIGITAL STAIR TREAD	
			
Size & Price	EP	30x151	U82
	AS	30x151	U81
	EP	30x120	U54
	AS	30x120	U87
	EP	30x90	U87
	AS	30x90	U77

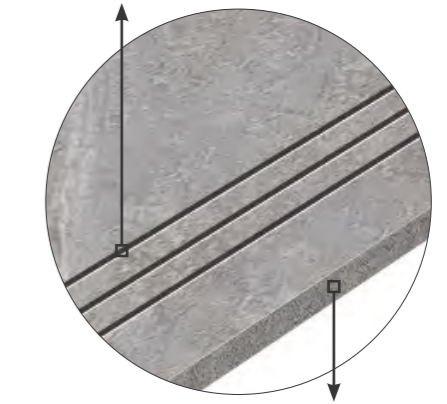

Stair tread with three non-slip incisions.
Peldaño de escalera con tres incisiones antideslizantes.





Stair tread with digital printing on the front, straight edge.
Peldaño de escalera con impresión digital frontal, borde recto.



SPECIAL PIECES



Porcelain			
D. OBLIQUE			
	CLOUD	Polished (EP)	29165 U55
	OAT	Polished (EP)	29167 U55
	DOLPHIN	Polished (EP)	29166 U55

Porcelain			
D. MIX			
	LAKESTONE MIX (CLOUD, OAT & DOLPHIN)	All in One (AS)	29164 U49
		Polished (EP)	29162 U49

White Body			
D. TRIANGLE			
	CLOUD	Natural (NT)	29223 U55
	OAT	Natural (NT)	29225 U55

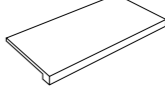
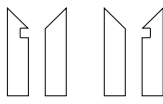
Complementary Pieces - Piezas Complementarias

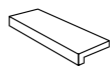
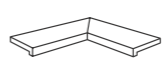
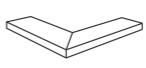
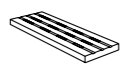







Shape	FINISHES	SKIRTING		TECHNICAL STAIR TREAD		S.K.I.	
							
Size & Price	EP	8x75,5	U43	30x151	U86	8x30	U53
	EP	8x60	U35	30x120	U75	8x30	U53
	EP	8x90	U44	30x90	U76	8x30	U53
	EP	8x75,5	U43	30x75,5	U76	8x30	U53

Porcelain							
							
		P.V. (POOL COPING) 20x90x1 cm 8x35,4x0,4 "	ANG.P.V. (POOL COPING INTERNAL CORNER) 90x90x1 cm 35,4x35,4x0,4 "	E.P.V. (POOL COPING EXTERNAL CORNER) 90x90x1 cm 35,4x35,4x0,4 "	REJ. (DRAINAGE GRATE) 15x45x2,3 cm 6x17,7x0,9 "	ANG.REJ. (ANGLE CORNER DRAINAGE GRATE) 45x45x2,3 cm 17,7x17,7x0,9 "	T.REJ. (SQUARE CORNER DRAINAGE GRATE) 15x15x2,3 cm 6x6x0,9 "
CLOUD	All in One (AS)	29996 U81	30003 U75	30006 U75	30009 U54	30012 U75	30015 U71
OAT	All in One (AS)	30001 U81	30004 U75	30008 U75	30011 U54	30013 U75	30017 U71
DOLPHIN	All in One (AS)	30002 U81	30005 U75	30007 U75	30010 U54	30014 U75	30016 U71

TECHNICAL CHARACTERISTICS

PACKING

Technical Characteristics - Características Técnicas

	 JOINT	 FROST PROOF	 VERSATILE	 RECTIFIED	 DIFERENT SHADES	 V1 V2 V3 V4 SHADE VARIATION	 VARIOUS GRAPHICS	 CLEANING NON-ABRASIVE
Polished (EP)	✓	✓	✓	✓	✓	✓	✓	✓
All in One (AS)	✓	✓	✓	✓	✓	✓	✓	✓

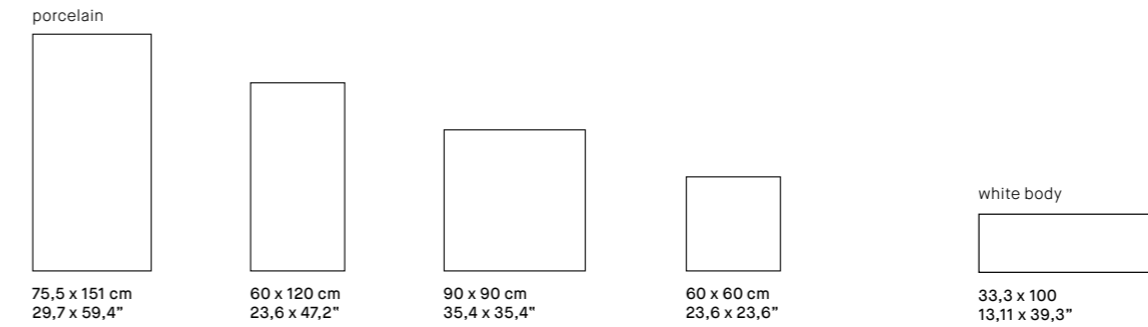

Applications - Aplicaciones

	Wall	Floor	
	NT	EP	AS
INTERIOR	yes	yes	yes
EXTERIOR	yes	yes	yes
TRAFFIC	yes	light	high
WET AREAS	yes	no	yes

Sizes - Formatos	Box - Caja			Pallet				Container 20' 24000 Kg.		
	Piezas	m ²	kg	Cajas	m ²	kg	Tamaño aprox. cm	Nº pallets	m ²	kg
75,5 x 151 x 1	1	1,14	26	44	50,16	1189	160 x 92 x 76	17	852,72	20213
60 x 120 x 1	2	1,44	33,18	27	38,88	921	120 x 80 x 75	26	1010,8	23942
90 x 90 x 1	2	1,62	37,96	22	35,64	860	105 x 95 x 75	27	962,28	23223
60 x 60 x 1	3	1,08	24,3	40	43,2	997	120 x 80 x 75	24	1036,8	23928
33,3 x 100 x 1,05	4	1,33	24	48	63,84	1177	118 x 110 x 81	20	1276,8	23540
inch	Units	ft ²	lb	Boxes	ft ²	lb	Approx. sizes inch	Nº pallets	ft ²	lb
29,7 x 59,4 x 0,39	1	12,27	37,68	44	539,92	2621	62,9 x 36,2 x 29,9	17	9178,6	44562
23,6 x 47,2 x 0,39	2	15,5	82,95	27	418,5	2030	47,2 x 31,4 x 29,5	26	10881	52783
35,4 x 35,4 x 0,39	2	17,44	88,18	22	383,62	1896	41,3 x 37,4 x 29,5	27	10357,9	51198
23,6 x 23,6 x 0,39	3	11,63	61,42	40	465	2198	47,2 x 31,4 x 29,5	24	11160	52752
13,11 x 39,3 x 0,41	4	14,31	52,91	48	687,16	2595	46,4 x 43,3x 31,8	20	13743,47	51897

Technical Data - Información Técnica

	DIN 51130	DIN 51097	UNE-ENV 126 33	BS 7976-2 (PTV)	ANSI A137.1 (DCOF)
All in One (AS)	R11	A + B + C	Class 3	+36 Wet	>0,42 Wet

MUSEUM

All colours and hues appearing in this catalogue should be considered approximate, only in view of the printing processes involved. The rights of all contents (texts, photographs, drawings, designs, etc.) of this catalogue remain the property of PERONDA GROUP S.A (or, failing that, they have the corresponding permissions of the owners). No part of this publication may be reproduced, stored in a retrieval system, or transmitted in any form or by any means, electronic, mechanical, photocopying, recording or otherwise, without the prior written permission of the copyright holders.

© PERONDA GROUP 2020

Av. Manuel Escobedo, 26
12200 Onda (Castellón) Spain
+34 964 602 012

