

**peronda**

POR  
CE  
LAIN

TI  
LES

**COLLECTION**



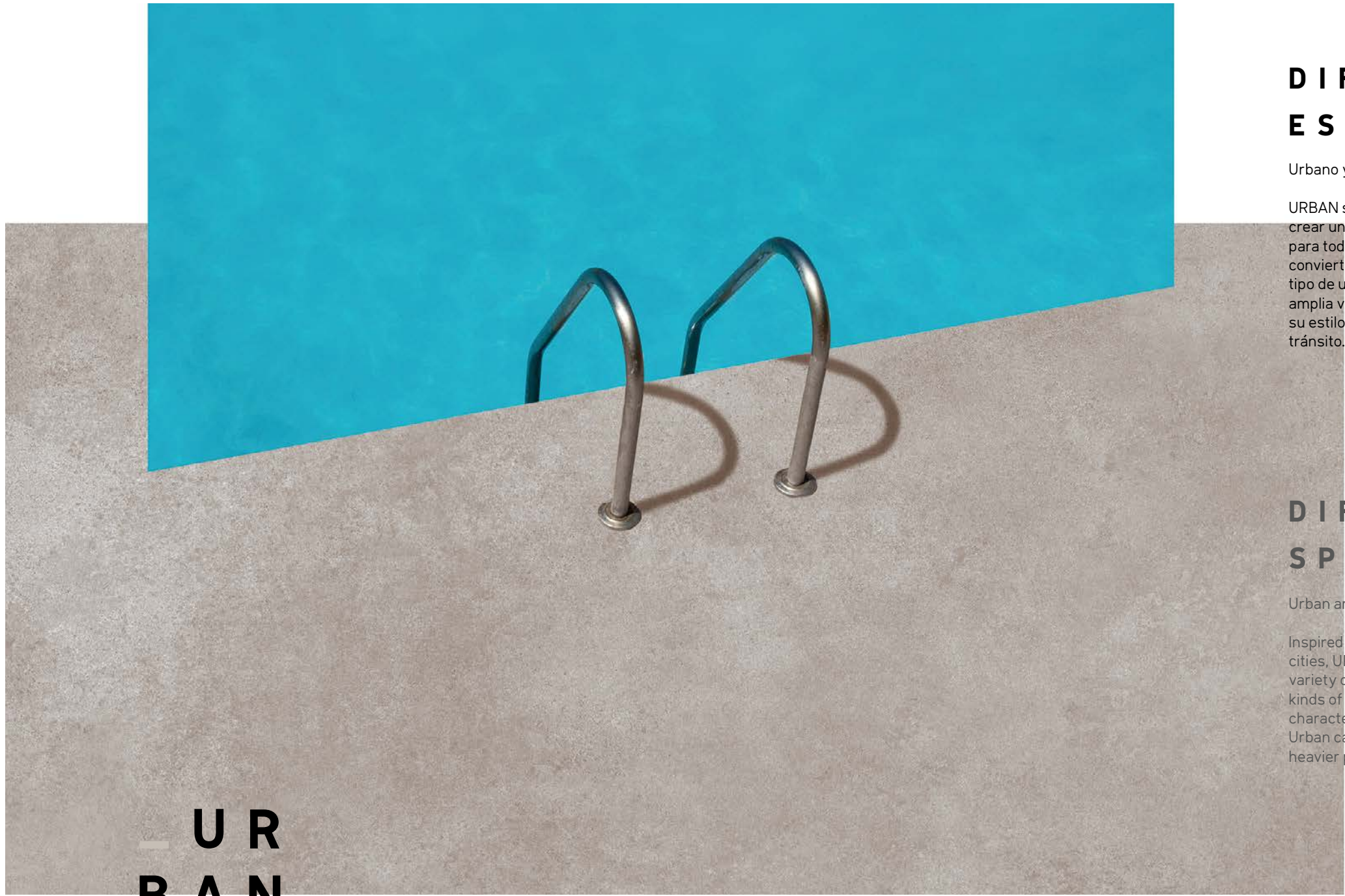

**— U R  
B A N**

## **D I F E R E N T E S E S P A C I O S**

Urbano y contemporáneo.

URBAN se inspira en el carácter cosmopolita de las ciudades para crear un concepto estético camaleónico y con personalidad perfecto para todo tipo de espacios. Su amplia variedad de formatos y acabados convierten a la colección URBAN en una selección pensada para todo tipo de usos y espacios. Sus inigualables características técnicas y su amplia variedad tonal ( cuatro colores diferentes ) consiguen trasladar su estilo minimal y atemporal tanto a proyectos residenciales como de tránsito.

## **D I F F E R E N T S P A C E S**

Urban and Contemporary

Inspired by the cosmopolitan atmosphere synonymous with big cities, URBAN is a chameleonic collection whose personality and wide variety of formats and finishes make it the perfect solution for all kinds of settings and applications. Thanks to its unbeatable technical characteristics, choice of four colours and timeless minimalist design, Urban can be used in both residential projects and places subject to heavier pedestrian traffic.



**MUD**

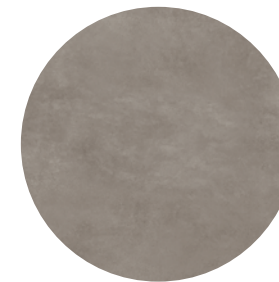

**SMOKE**



**SILVER**

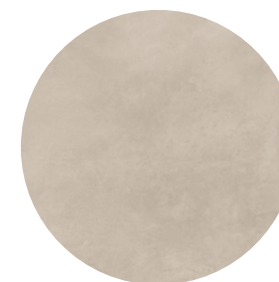

**ECRU**

**— U R  
B A N**



**M U D**



Cemento y tierra. La mezcla entre lo cosmopolita y la materia hecha color. Referencia al barro como material maleable y urbano sin perder su carácter constructivo.

Clay and cement. A combination of cosmopolitanism and material brought to life through colour, emphasizing clay's malleability and urban constructive appeal.

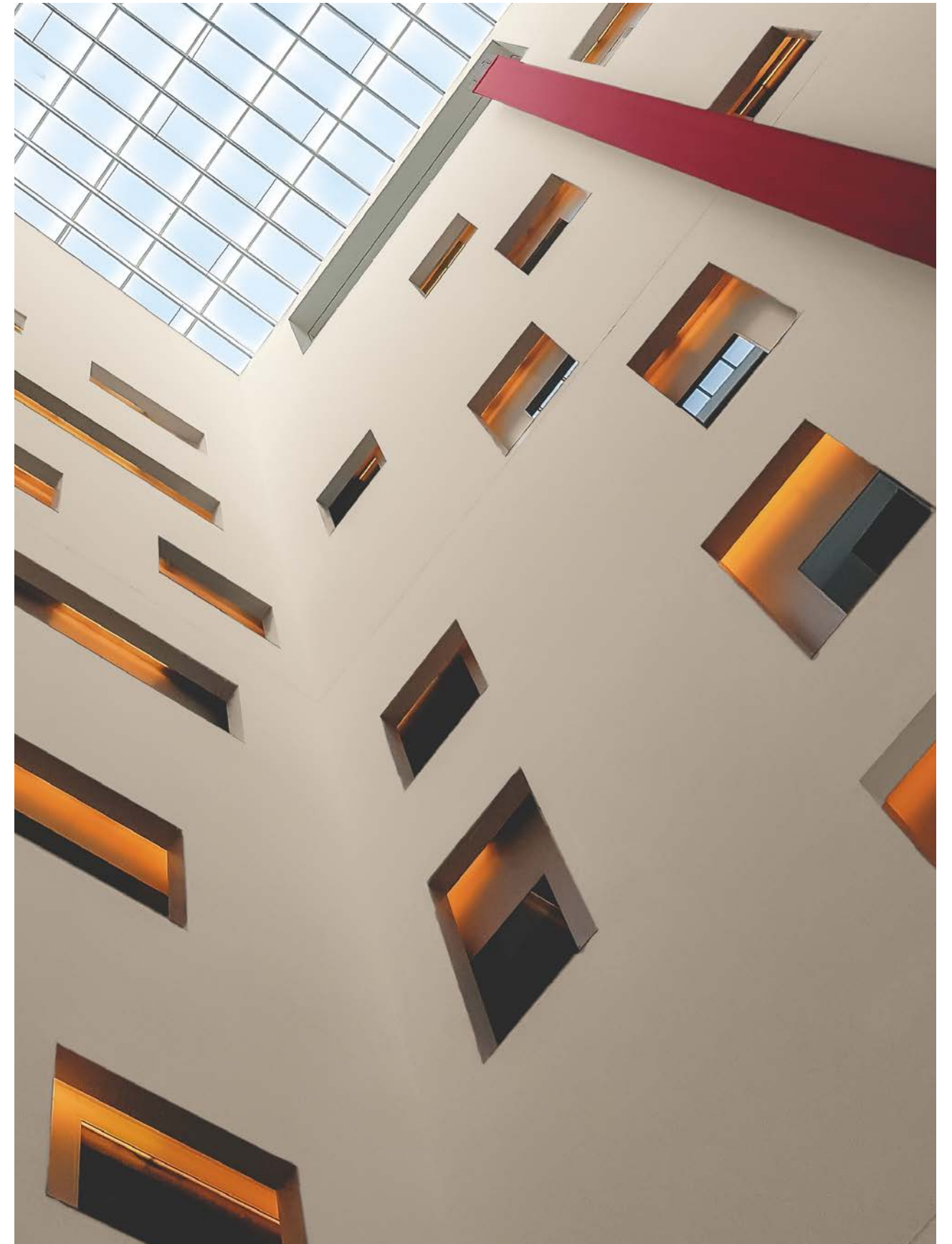



URBAN MUD 90\*90 antislip \_ URBAN ECRU 29\*90 soft

COLLECTION URBAN \_MUD

**\_ U R  
B A N**



**S M O K E**

PÁGINAS 12 \_17



URBAN  
**S M O K E**

Asfalto y ciudad. La tonalidad más relacionada con las grandes urbes en su versión más cuidada. Gris saturado de intensidad media que nos traslada al centro de la ciudad.

Cities and asphalt. An attractive version of the colour most closely associated with big metropolises: a mid-shade of saturated grey, evocative of city centres.

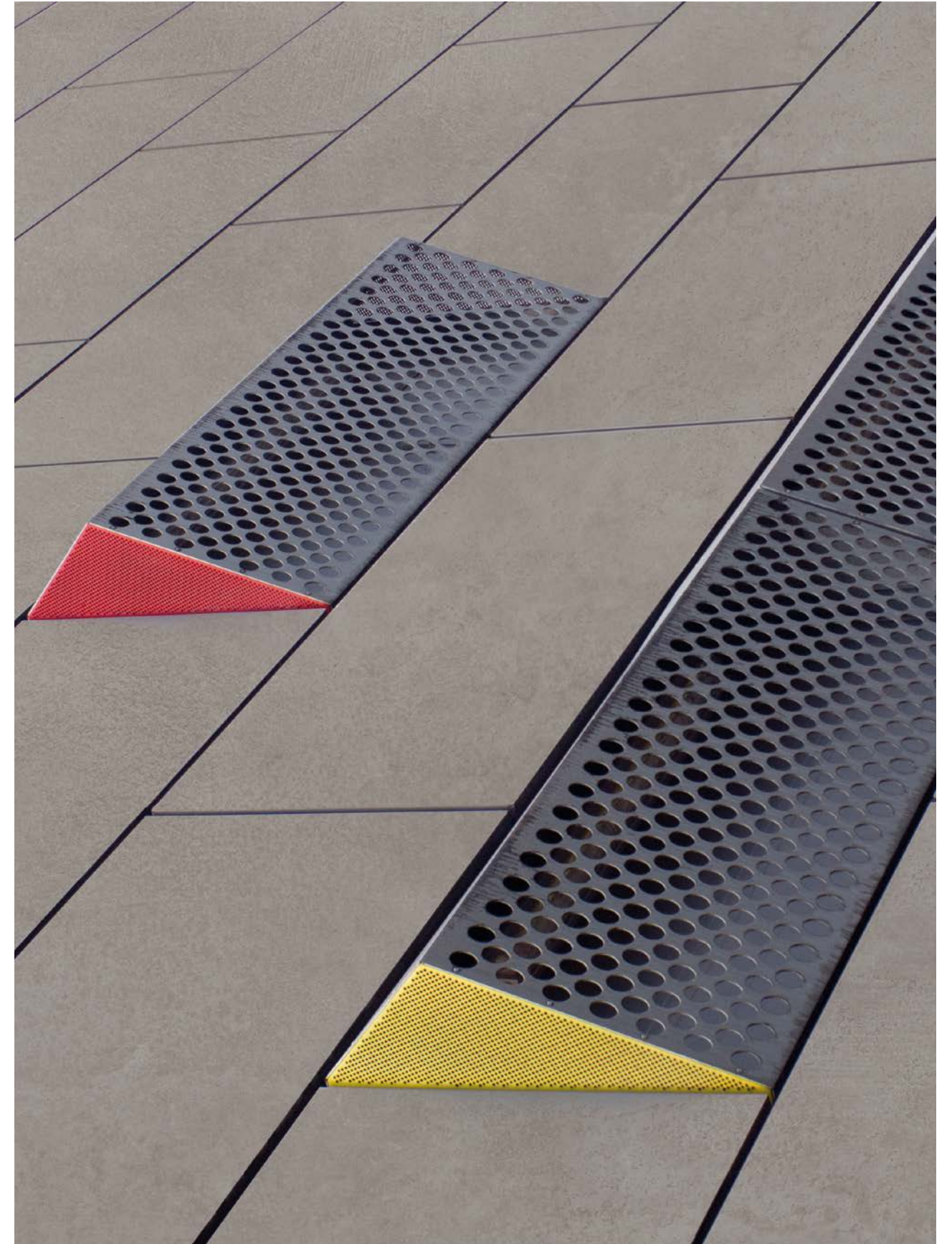





URBAN SMOKE 90\*90 soft \_ RHOM SILVER \_ URBAN SMOKE 90\*90 antislip \_P. URBAN SMOKE

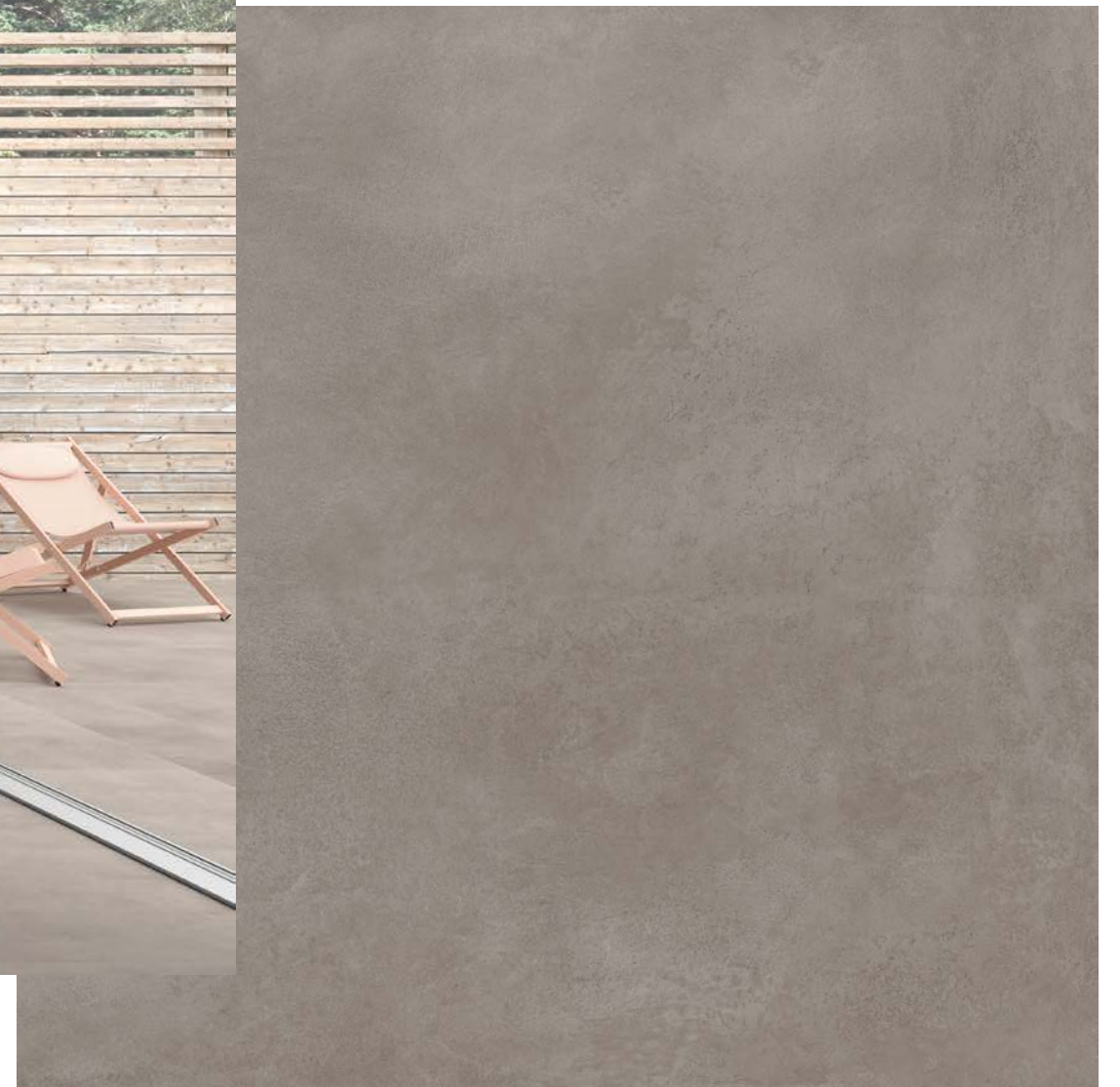

COLLECTION URBAN \_ SMOKE

**— U R  
B A N**



**S I L V E R**

PÁGINAS 18 \_23



URBAN  
**SILVER**

Metal y luz. El metal como material de construcción en las ciudades que les confiere el aspecto plateado, el brillo y la luminosidad que nos atrae hacia ellas.

Metal and light. Metal as a building material in cities, lending them that shiny silver luminosity that draws all eyes.



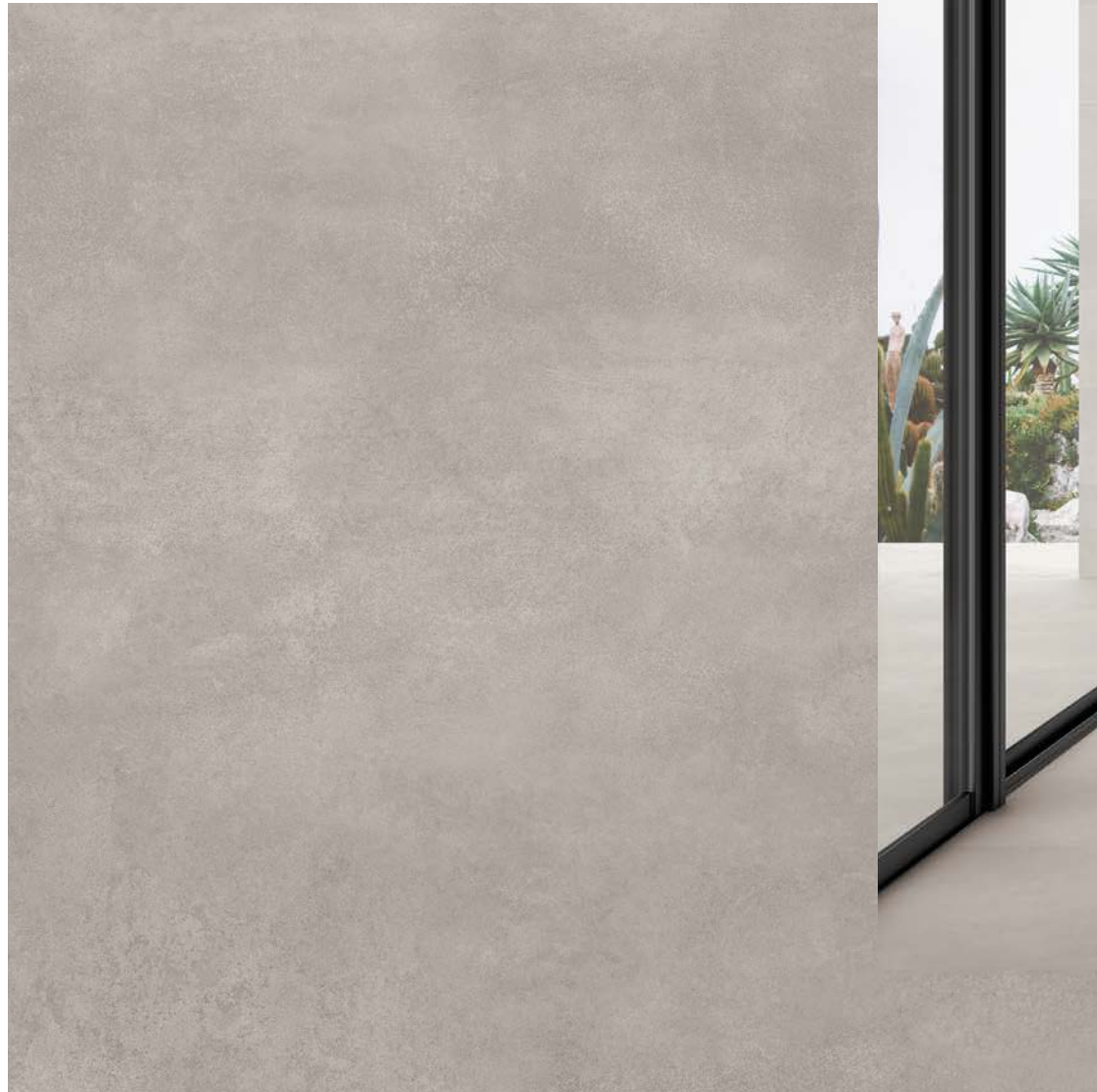

COLLECTION URBAN \_SILVER



URBAN SILVER 60\*120 antislip \_URBAN SILVER 60\*120 soft \_URBAN SILVER 30\*60 soft

**\_ U R  
B A N**



**E C R U**

PÁGINAS 24 \_29



URBAN  
**ECRU**

Hormigón y calidez. Materiales de aspecto crudo, aparentemente sin terminar que se convierten en tendencias decorativas, muchas veces inesperadas, que aportan calidez a los espacios.

Warmth and concrete. Materials with an untreated, apparently unfinished appearance. Materials that often unexpectedly become new trends in design, infusing living spaces with warmth.

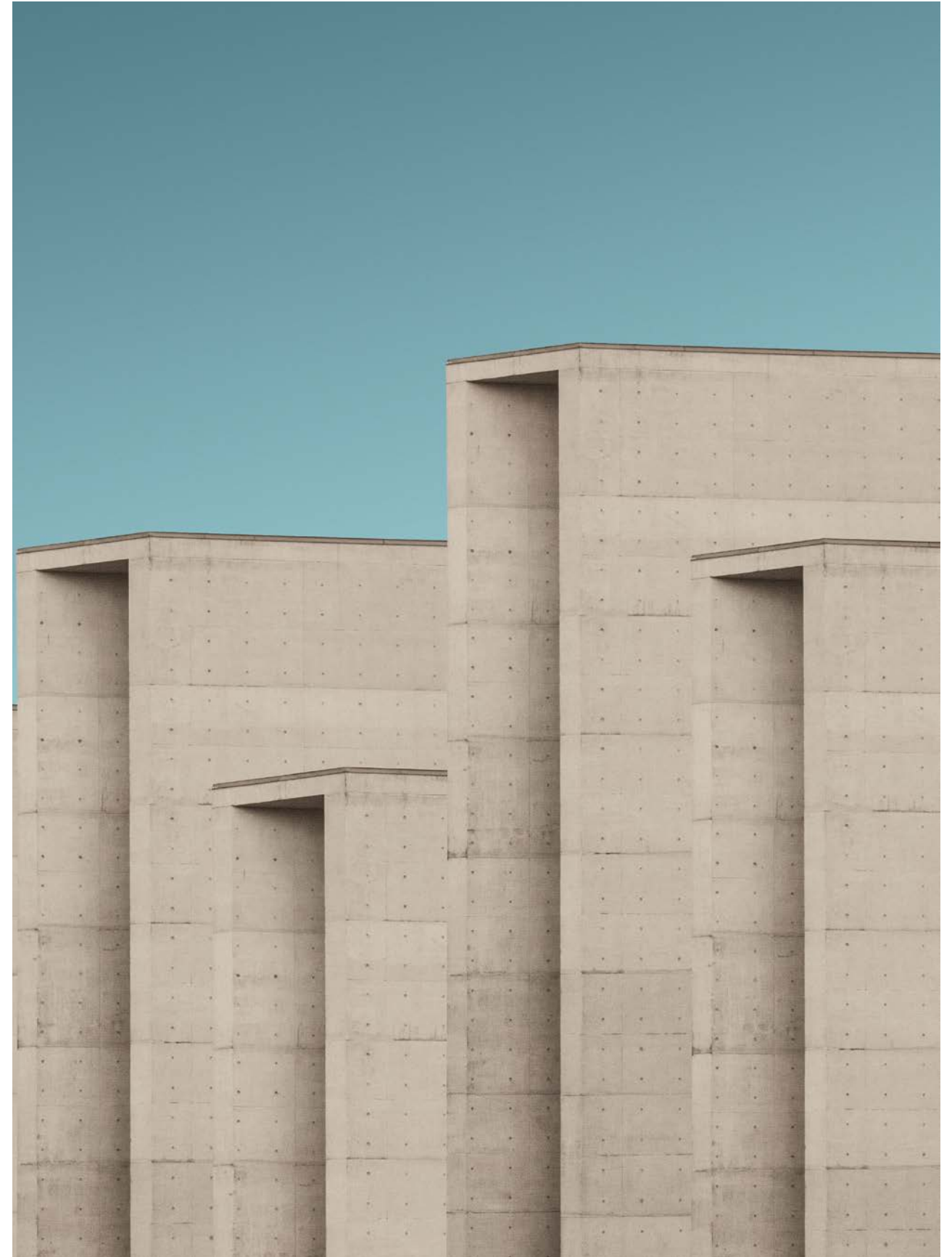



URBAN ECRU 60\*60 antislip \_URBAN ECRU 60\*120 soft \_D. URBAN MOSAIC ECRU soft  
P.V. URBAN ECRU \_ANG.P.V. URBAN ECRU \_E.P.V. URBAN ECRU  
REJ. URBAN ECRU \_ANG.REJ. URBAN ECRU \_T.REJ. URBAN ECRU

COLLECTION URBAN \_ECRU

— U R  
B A N



PÁGINAS 30 \_37

T E C H N I C A L  
I N F O R M A T I O N



# FORMATS

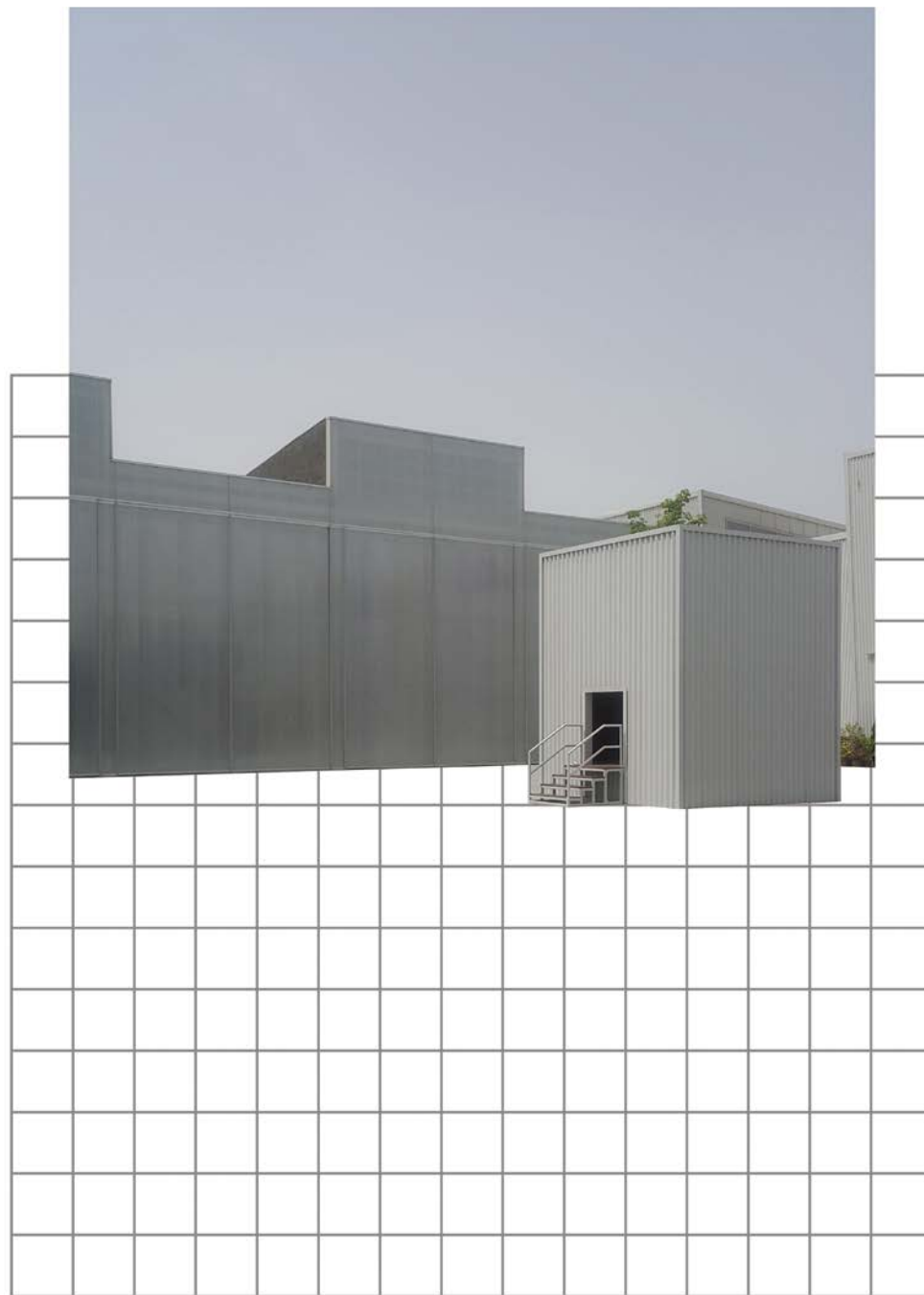

90

90 \* 90 \* 1cm | 36 \* 36"

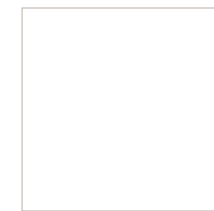

60

60 \* 60 \* 1cm | 24 \* 24"

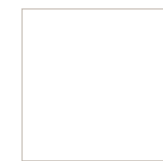

45

45,6 \* 45,6 \* 0,8 | 18 \* 18"

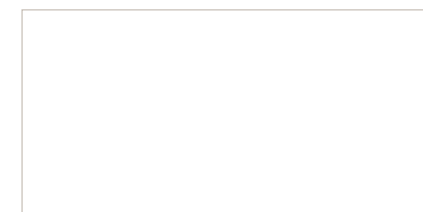

60 \* 120

60 \* 120 \* 1cm | 24 \* 48"

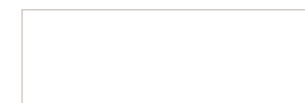

29 \* 90

29 \* 90 \* 1cm | 12 \* 36"



10 \* 60

9,9 \* 60 \* 1cm | 4 \* 24"

# REFERENCES

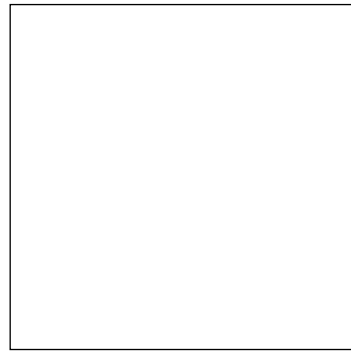

17 patterns

90 \* 90 \* 1 cm | 36 \* 36"

RECTIFIED	SOFT BN48	ANTISLIP BN90
ECRU	24032	24036
MUD	24031	24037
SILVER	24033	24038
SMOKE	24034	24039

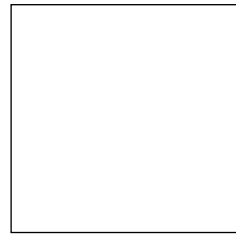

32 patterns

60 \* 60 \* 1 cm | 24 \* 24"

RECTIFIED	SOFT BN33	ANTISLIP BN88
ECRU	24132	24136
MUD	24133	24137
SILVER	24134	24138
SMOKE	24135	24139

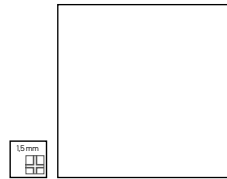

32 patterns

45,6 \* 45,6 \* 0,8 | 18 \* 18"

NO RECTIFIED	SOFT BN59
ECRU	24270
MUD	24271
SILVER	24273
SMOKE	24272

## RHOM. URBAN

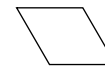

14,8 \* 17 cm | 6 \* 7"

NO RECTIFIED	SOFT P17
ECRU	24969
MUD	24970
SILVER	24971
SMOKE	24972

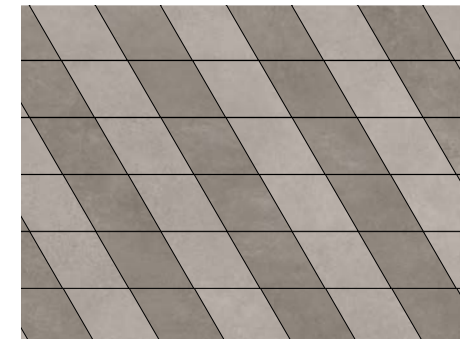

51 patterns

29 \* 90 \* 1 cm | 12 \* 36"

RECTIFIED	SOFT BN48
ECRU	24602
MUD	24605
SILVER	24608
SMOKE	24611

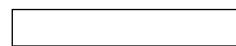

128 patterns

9,9 \* 60 \* 1 cm | 4 \* 24"

RECTIFIED	SOFT BN97
ECRU	24625
MUD	24627
SILVER	24631
SMOKE	24634

## D. URBAN MOSAIC

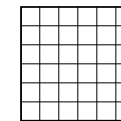

30 \* 30 cm | 12 \* 12"

NO RECTIFIED	SOFT P38
ECRU	24450
MUD	24451
SILVER	24452
SMOKE	24453

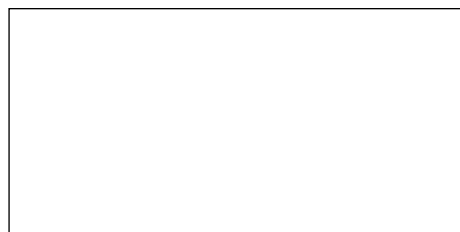
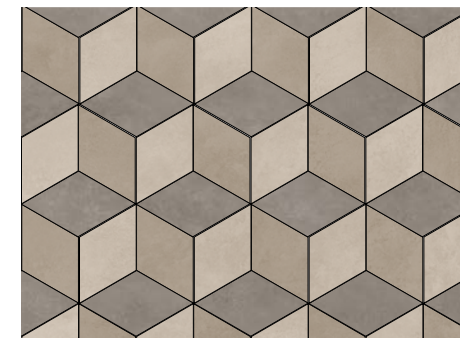

16 patterns

60 \* 120 \* 1 cm | 24 \* 48"

RECTIFIED	SOFT BN72	ANTISLIP BN116
ECRU	24669	24678
MUD	24670	24680
SILVER	24672	24679
SMOKE	24671	24677

## MILA

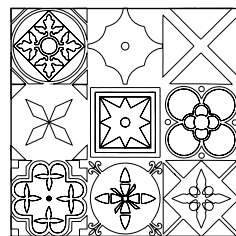

5 patterns

60 \* 60 \* 1 cm | 24 \* 24"

RECTIFIED	SOFT BN40
WARM	24953
COLD	24952

## D. MILA MOSAIC

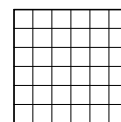

30 \* 30 cm | 12 \* 12"

NO RECTIFIED	SOFT P37
WARM	23441
COLD	23442

## D. URBAN SPAC

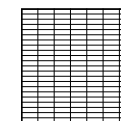

30 \* 30 cm | 12 \* 12"

NO RECTIFIED	SOFT P58
ECRU	24454
MUD	24455
SILVER	24456
SMOKE	24457

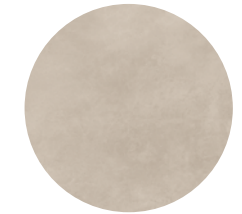
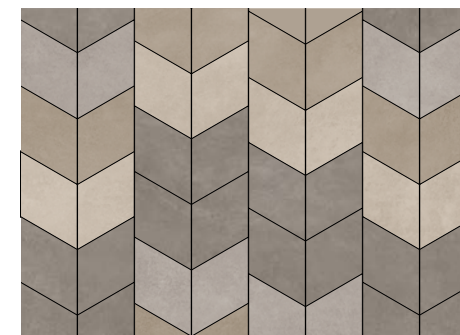

ECRU



MUD

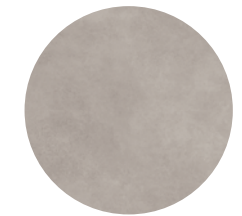

SILVER

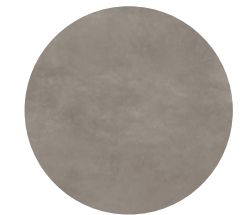

SMOKE



MILA warm





MILA cold

Ejemplos de posibles combinaciones.  
Se pueden realizar en todos los colores.  
Examples of possible combinations.  
Available in all colours.



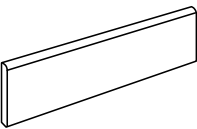
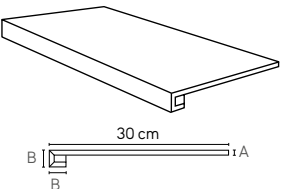
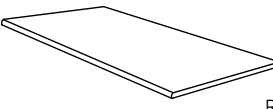
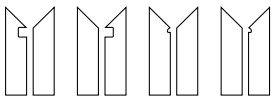

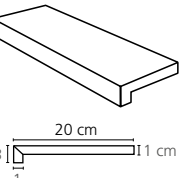
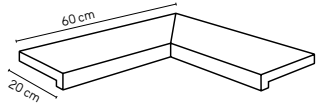
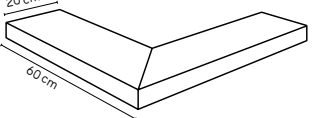
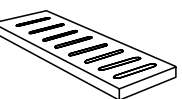
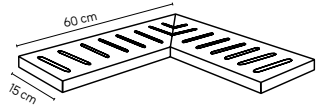
24819 ALUMINIO/60 \_60 \* 0,5 cm | 24 \* 0,2" \_ P35

# COMPLEMENTARY PIECE

PIEZA COMPLEMENTARIA   COMPLEMENTARY PIECE			*Pedido mínimo 10 unidades   Minimum order 10 items		
<b>Rodapie</b> Skirting  	<b>Peldaño técnico</b> Technical stair - thread  	<b>Peldaño romo</b> Rounded stair - thread  	*S.K.I. *S.K.D. *Z.R.I. *Z.R.D.		
8 * 90/SF cm   3 * 36" P44 8 * 60 cm   3 * 24" P13 8 * 45,6 cm   3 * 18" P9	30 * 90 cm   12 * 36" P76 30 * 60 cm   12 * 24" P54 30 * 120 cm   12 * 48" P75 A=1 cm B=3 cm	30 * 90 cm   12 * 36" P61 30 * 60 cm   12 * 24" P64 30 * 120 cm   12 * 48" P77	8 * 30/SF cm   3 * 12" P55 8 * 30 cm   3 * 12" P48		

PIEZA ESPECIAL PISCINA   SPECIAL PIECE POOL			*Pedido mínimo 10 unidades   Minimum order 10 items		
<b>Peldaño Vierteagua</b> Pool Coping  	<b>Peldaño vierteagua angulo</b> Pool Coping internal corner  	<b>Peldaño vierteagua esquina</b> Pool Coping external corner  			
20 * 60 cm   8 * 24 P61	20 * 60 cm   24 * 24" P70 (PACK 2 units)	20 * 60 cm   24 * 24" P70 (PACK 2 units)			
<b>Rejilla</b> Drainage grate  	<b>Angulo rejilla</b> Angle corner drainage grate  	<b>Taco rejilla</b> Square corner drainage grate  			
15 * 60 * 2 cm   6 * 24" P54	15 * 60 * 2 cm   24 * 24" P75 (PACK 2 units)	15 * 15 * 2 cm   6 * 6" P85			

# TECHNICAL INFORMATION

CARACTERÍSTICAS TÉCNICAS   TECHNICAL CHARACTERISTICS						
joint 	frost proof 	versatile 	full body 	diferent shades 	shade variation 	various graphics 

\* Except in 45\*45. Joint to 1,5mm. Excepto en 45\*45, junta a 1,5 mm.

CARACTERÍSTICAS TÉCNICAS ANTIDESLIZAMIENTO   ANTI-SLIP CHARACTERISTICS			
Ensayo   Essay	Características   Features	Resultado   Result	
		SOFT	ANTISLIP
DIN 51130	Ángulo crítico (Pies calzados)   Critical angle (footwear)	R10	R12
DIN 51097	Ángulo crítico (Pies descalzos)   Critical angle (Wet loaded barefoot)	A+B	A+B+C
BS-7976-2	Antideslizamiento (Test del péndulo)   Slip resistance (Pendulum test)	+36 Wet	+36 Wet
UNE-ENV-12633	Antideslizamiento (Test del péndulo)   Slip resistance (Pendulum test)	Class 1	Class 3
ANSI A.1371	Coefficiente de Fricción Dinámico   Dynamic Coefficient of Friction	> 0,42 Wet	> 0,42 Wet
ISO 10545-6	Resistencia a la abrasion profunda   Resistance to Deep Abrasion	< 175 mm <sup>3</sup>	< 175 mm <sup>3</sup>

EMBALAJE   PACKING									
Formato   Sizes	Cajas   Boxes			Pallet			Cont./20' 21500 kg.	Cont./20' 24000 kg.	
	Piezas	m <sup>2</sup>   sq. m	kg	Cajas	m <sup>2</sup>   sq. m	kg	Tamaño cm aprox.	m <sup>2</sup>   sq. m	m <sup>2</sup>   sq. m
29 * 90 * 1	3	0,78	18,97	54	42,12	1074	105 * 95 * 75	863,28	963,66
45,6 * 45,6 * 0,8	5	1,04	18,8	66	68,64	1288,8	120 * 80 * 105	1166,61	1302,26
60 * 120 * 1	2	1,44	33,18	27	38,88	943,8	120 * 80 * 75	908,61	1014,26
60 * 60 * 1	3	1,08	24,3	36	38,88	922,8	120 * 80 * 75	929,83	1037,95
9,9 * 60 * 1	13	0,77	16,45	72	55,44	1208	100 * 100 * 94	996,62	1112,51
90 * 90 * 1	2	1,62	37,96	22	35,64	885	105 * 95 * 75	891	994,6
inch	Units	ft <sup>2</sup>	lb	Boxes	ft <sup>2</sup>	lb	Sizes inch approx.	ft <sup>2</sup>	ft <sup>2</sup>
11 7/16 * 35 7/16 * 3/8	3	8,40	44,09	54	453,38	2313,05	41 5/16 * 37 3/8 * 29 1/2	9292,34	10372,84
17 15/16 * 17 15/16 * 5/16	5	11,19	41,45	66	738,84	2789,33	41 5/16 * 31 1/2 * 41 5/16	12557,38	14017,54
23 5/8 * 47 1/4 * 3/8	2	15,50	73,16	27	418,5	2028,6	41 5/16 * 31 1/2 * 29 1/2	9780,26	10917,5
23 5/8 * 23 5/8 * 3/8	3	11,63	53,59	36	418,5	1982,3	41 5/16 * 31 1/2 * 29 1/2	10008,72	11172,53
3 7/8 * 23 5/8 * 3/8	13	8,29	36,27	72	596,76	2637,18	39 3/8 * 39 3/8 * 37	10727,64	11975,04
35 7/16 * 35 7/16 * 3/8	2	17,44	83,70	22	383,63	1896,3	41 5/16 * 37 3/8 * 29 1/2	9590,72	10705,92

(Los pesos aquí reflejados pueden sufrir ligeras variaciones en función del lote de producción. Weights shown here may slightly vary depending on the production lot.)

Debido a los procesos de impresión, los colores que aparecen en este catálogo deben considerarse aproximados, y no exactos. Los derechos de todos los contenidos (textos, fotografías, dibujos, diseños etc) del presente catálogo son propiedad de PERONDA GROUP, S.A (o en su defecto, cuentan con los correspondientes permisos y autorizaciones de sus titulares). No está permitida la reproducción total o parcial de esta publicación, ni su tratamiento informático, ni la transmisión de ninguna forma o por cualquier medio, ya sea electrónico, mecánico, por fotocopia, por registro u otros medios, sin el permiso previo y por escrito de los titulares del copyright.

All colours and hues appearing in this catalogue should be considered approximate, only in view of the printing processes involved. The rights of all contents (texts, photographs, drawings, designs, etc.) of this catalogue remain the property of PERONDA GROUP, S.A (or, failing that, they have the corresponding permissions and authorizations of the owners). No part of this publication may be reproduced, stored in a retrieval system, or transmitted in any form or by any means, electronic, mechanical, photocopying, recording or otherwise, without the prior written permission of the copyright holders.

PERONDA GROUP 2020  
Av. Manuel Escobedo, 26.  
12200 Onda (Castellón) España

**peronda**

**peronda.com**

Av. Manuel Escobedo, 26 \_ P.O Box 51  
12200 **Onda (Castellón)** España  
**964 602 012** \_ f. 964 600 361